



# FOREST DRAPERY HARDWARE

RETAIL PRICE GUIDE VOLUME 21

## AT FOREST DRAPERY HARDWARE WE WANT TO BRING

**YOUR WINDOW TREATMENT DESIGNS TO LIFE.** Whether you are looking for basic track, decorative wood or decorative metal, the latest in motorization options, or roller shades, Forest has a solution for you. Components featured in this catalog are stocked in our Atlanta warehouse ready to ship today. Assembled orders, built to your exact specifications, typically ship in 7-10 business days.



## WHERE DESIGN BECOMES REALITY

ON THE COVER: 1897 New England home transformation featuring the Forest Dresden Traversing Collection. Interior design by Reid Design, Lexington, MA. Drapery by Designer Draperies of Boston, South Boston, MA. Photo credit to Greg Premru.

**WARRANTY & RETURNS:** All returns must be approved prior to returning. A 25% restocking fee will be applied. No returns accepted after 30 days of receipt of order or on custom orders. Please inspect all packages upon receipt, note any loss or damage on the freight bill and immediately notify Forest Drapery Hardware. Claims must be reported within 3 business days. Forest Drapery Tracks are warranted for 10 years. All Forest Shuttle motors and the Forest Atlantis motor are warranted for 10 years. All other motors are warranted for one year. Forest Roller Shades are warranted for 1 year. Warranties do not apply to wear resulting from normal usage, damage from mishandling, abuse, or exposure due to climate conditions over which we have no control. No Forest products are warranted for outdoor use. All prices subject to change without notice. \*Ripplefold is a trademark of Kirsch.

# TABLE OF CONTENTS

## TRACK, PANEL AND ROMAN BLIND SYSTEMS

CS Heavy Duty Track System . . . . .	3-6
CL Heavy Duty Cam Lock Track System . . . . .	3-6
CM Heavy Duty Ceiling Mount Track System . . . . .	3-6
CCS Heavy Duty Corded Track System . . . . .	7-8
RTS Recessed Track System . . . . .	9-10
KS Light-Medium Duty Klick System . . . . .	11-12
DS Design System . . . . .	11-12
DSXL Design System XL . . . . .	13-14
DSXL LED Design System XL with LED Lighting . . . . .	13-14
RBS Roman Blind System . . . . .	15-16
RBS XL Roman Blind System XL . . . . .	17-18
PS Panel System . . . . .	19-20

## BENDING/CURVING, BATONS & WORKROOM

Bending & Curving . . . . .	21-22
Batons . . . . .	23
Workroom Components . . . . .	24
FES Forest Easyflex System . . . . .	24

## DECORATIVE METAL HARDWARE

GLASGOW 1 3/8" Acrylic Pole Sets . . . . .	27-28
DRESDEN 1 1/8" Decorative Pole Sets . . . . .	29-30
DEVENTER DECO 1 1/8" Pole Sets . . . . .	31-32
LISBON 1 3/16" Decorative Pole Sets . . . . .	33-34
AVEIRO 1 3/16" Decorative Pole Sets . . . . .	35-36
PORTO 3/4" Wrought Iron Pole Sets . . . . .	37-38
PORTO 1 3/16" Wrought Iron Pole Sets . . . . .	39-40
DRESDEN TRAVERSING 1 1/8" . . . . .	41-42
DRESDEN CORDED 1 1/8" . . . . .	43-44
DRESDEN CORDED 1 9/16" . . . . .	45-46
DEVENTER CRS TRAVERSING 1 1/8" . . . . .	47-48
FRANKFURT TRAVERSING 1" Square Rail . . . . .	49-50
STUTTGART TRAVERSING - 3 Contemporary Designs	
Rectangle Rail Hand Draw Traversing . . . . .	51-52
C Rail Hand Draw Traversing . . . . .	53-54
Oval Rail Hand Draw Traversing . . . . .	55-56

## DECORATIVE WOOD HARDWARE

VALENCIA 1 3/4" Pole Sets . . . . .	59-60
SEVILLE 1 3/8" Pole Sets . . . . .	61-62
CORDOBA 2" Pole Sets . . . . .	63-64
GRANADA 2 3/4" Pole Sets . . . . .	65-66
CORDOBA 2" & GRANADA 2 3/4" Traversing . . . . .	67-68

## MOTORIZATION

<b>NEW!</b> SHUTTLE Motors . . . . .	71-72
FMS Motorized Track System . . . . .	73-74
RMS Recessed Motorized System . . . . .	75-76
DSXL LED Motorized Design System + LED Lighting . . . . .	77-78
RBS Motorized Roman Blind System . . . . .	79-80
BCS Motorized Blind Contract System . . . . .	81-82
DRESDEN Motorized Decorative Metal . . . . .	83-88
DEVENTER MRS Motorized Decorative Metal . . . . .	89-90
CORDOBA & GRANADA Motorized Wood . . . . .	91-92

## ROLLER SHADES

APOLLO Basic Roller Shades . . . . .	95-96
MERCURY Decorative Roller Shades . . . . .	97-102
ATLANTIS Motorized Heavy Duty Roller Shades . . . . .	103-104
<b>NEW!</b> Roller Shade Fabric Options . . . . .	105-106

## APPENDIX

Terms and Conditions . . . . .	109
Ordering Instructions . . . . .	110
Returns, Warranty & Care . . . . .	110
Ripplefold Carrier Counts . . . . .	111-112
Product Support . . . . .	113-114
Child Safety . . . . .	114

# 25 YEARS STRONG - A HISTORY PRESENTED

## 2003

Forest prints its first catalog, known internally as the "32-Pager". Today the catalog is 114 pages.



## 2005

In 2005 the Retail Price Guide, RPG, is launched.



## 1995-2020

In 1995 Forest came to the United States from The Netherlands in the form of a makeshift operation housed in a series of garages. In 2000 the company opened the doors of a commercial warehouse in Cartersville, Georgia. Today Forest calls a 40,000 square foot facility home and is proud to be 25 years strong. Please enjoy this history of the company as presented through a collection of catalog covers through the years.

## 2021

It's 2021 and Forest, along with the rest of the world, continues to battle the economic and social consequences of the Covid 19 pandemic. We are thankful to be standing strong with our loyal customers, vendors and Forest team members.



## 2019-20

2019-20 Brought expansion in the area of integration and motor controls for drapery and roller shade motors. Forest continues to be the only manufacturer to offer a 10-year warranty on all drapery and tubular motors.



## 2018

2018 an updated U.S. website was launched, forestdh.com.

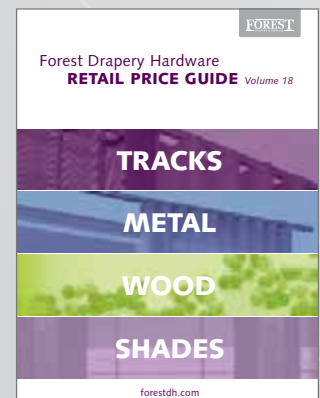

# THROUGH CATALOG COVERS

## 2008-2011

This was the period of three separate catalogs. Track systems were in the "RPG", with decorative metal in a separate Busche catalog and wood in a Zabala catalog. This way of going to market lasted until 2012.

# F25

25 YEARS STRONG

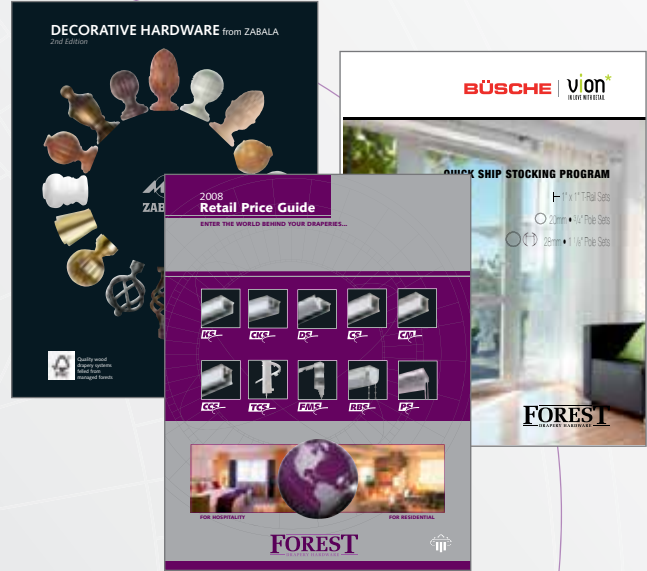

## 2015-16

2015-2016 Saw the launch of forestgroup.com and roller shades came on the scene. Today Forest is expanding its roller shade program to include the lines of in-stock fabrics to choose from - Essentials, Designer, and Exclusives.



## 2014

Forest turn its focus to motorization with an introduction to the automation revolution. A revolution that is in the forefront of all Forest products today.



## 2012-13

Streamlining operations and the catalog, Forest moved to a new 40,000 square foot facility in 2012 and introduced a catalog with all collections in one book.

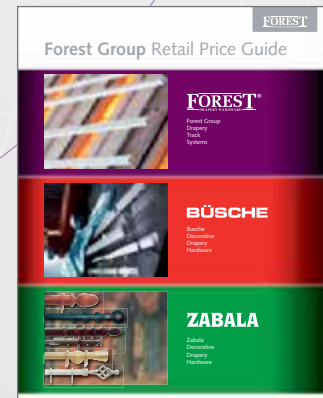



# FOREST DRAPERY TRACK SYSTEMS

A track for every design requirement . . .



**CS**



**CL**



**MTS**

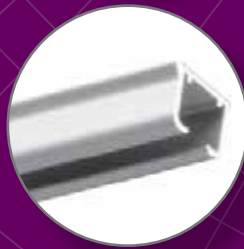

**KS**



**DS<sup>XL</sup>**  
LED



**RBS**



Forest Drapery Track Systems are installed worldwide in more than 100 countries, in both residential and commercial projects. Features include bending and curving options, easy installation, and ultra quiet operation.

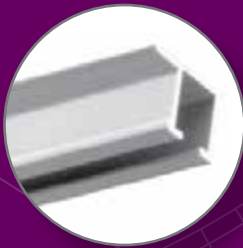

**CM**



**CCS**



**DS**



**DS<sup>XL</sup>**



**RBS<sup>XL</sup>**



**PS**

# TRACKS

CS | CL | CM | CCS | RTS | KS | DS | DSXL | DSXL LED | RBS | RBS XL | PS | BENDS & CURVES | BATONS | WORKROOM & FES







TRACKS CS CL CM



Scan for more information on FOREST Track Systems



-  25 White
-  59 Black
-  65 Brown
-  90 Silver



-  25 White

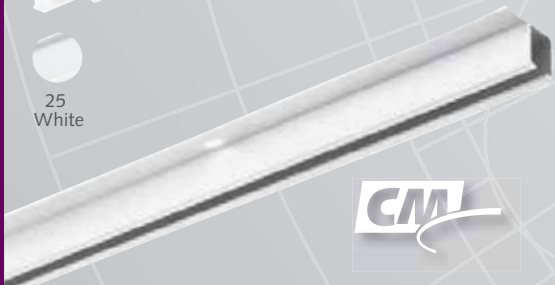

-  25 White

## CS<sup>®</sup> CONTRACT SYSTEM CL CAM LOCK TRACK CM CEILING MOUNT TRACK

- Heavy duty aluminum extrusion, white, powder coated, and lubricated with a patented process.
- Maximum weight is 6 lbs/ft.
- CS track can be bent and curved. An exact size template is required. See pages 21-22 for more information.
- Hand or baton draw, one or two way.
- Stackback: Ripplefold - 6" per width, pinchpleat - 7" per width, cubicle - 5" per width.







### ASSEMBLED PRICING

Includes track, masters, pinchpleat or ripplefold carriers, brackets, and 36" white fiberglass baton (See all batons page 23). Freight is additional.

	first 4 feet	ea. add'l foot
CS White	\$126.35	\$12.43
CS Black, Brown, Silver	\$138.99	\$13.68
CL White only	\$128.88	\$12.69
CM White only	\$109.90	\$9.11

### BATON OPTIONS

Fiberglass batons in 36", 48", 60" and 72" lengths and these colors. See all batons page 23.

-  White
-  Satin Brass
-  Black
-  Brown 48" only
-  Bronze
-  Silver



# TRACKS

CS | CL | CM | CCS | RTS | KS | DS | DSXL | DSXL LED | RBS | RBS XL | PS | BENDS & CURVES | BATONS | WORKROOM & FES











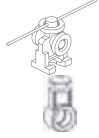









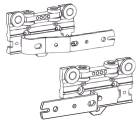

CS	CL	CM	COMPONENT	PRICE	CS	CL	CM	COMPONENT	PRICE
•			CS Contract System Track 51012-25 white 12' 51014-25 white 14' 51016-25 white 16' 51020-25 white 20'	\$3.10/ft. 20 tracks /bundle				3901-25 59 black, 65 brown, 90 silver +10% Ceiling Splice/Bracket	\$2.10 ea. \$1.75 ea. /box of 50
			51016-59 black 16' 51020-59 black 20' 51016-65 brown 16' 51016-90 silver 16'	\$3.41/ft. 20 tracks /bundle	•			53202-25 59 black, 65 brown, 90 silver +10% 3" Smart Klick Wall Bracket w/ wide base, adjusts 3-4.5"	\$3.10 ea. \$2.59 ea. /box of 100
•			CL Cam Lock Track 51512-25 white 12' 51514-25 white 14' 51516-25 white 16' 51519-25 white 19'	\$3.37/ft. 20 tracks/ bundle	•			53206-25 59 black, 65 brown, 90 silver +10% 6" Smart Klick Double Wall Bracket w/ wide base adjusts 2.5"-4" & 6"-7.5"	\$5.10 ea. \$4.24 ea. /box of 50
•			CM Ceiling Mount Track 51212-25 white 12' 51214-25 white 14' 51216-25 white 16' Holes every 16"	\$3.41/ft. 20 tracks/ bundle	•			3280-25 59 black, 65 brown, 90 silver +10% 3" Wall Bracket, heavy duty projection 2 1/2"	\$11.57 ea. \$9.64 ea. /box of 20
•			3906-25 59 black, 65 brown, 90 silver +10% Track Connector	\$16.16 ea. 10/box	•			3281-25 59 black, 65 brown +10% 6" Double Wall Bracket, heavy duty projection 1 1/2", 5 1/2"	\$16.58 ea. \$13.82 ea. /box of 15
•	•	•	52304-25 59 black, 65 brown, 90 silver +10% End Cap - Short For one way draws	\$3.11 ea. \$2.59 ea. /box of 400	•			32801-25 59 black, 90 silver +10% Wall Bracket Cover use with 3280 & 3281	\$2.98 ea. \$2.49 ea. /box of 50
•	•	•	52301-25 59 black, 65 brown, 90 silver +10% End Cap w/ Economy Slide Add 2004-25 w/ Ripplefold	\$1.13 ea. \$0.94 ea. /box of 400	•			53502-25 3" Wall Bracket adjusts 3" - 4 1/2" w/ metal cam lock	\$4.05 ea. \$3.37 ea. /box of 100
•	•	•	52302-25 Right Return 52303-25 Left Return End Cap w/ Return Plate, Snap for pinch pleat or Ripplefold	\$2.16 ea. \$1.80 ea. /box of 100	•			53506-25 6" Double Wall Bracket adjusts 2 1/2"-4" & 6"-7 1/2" w/ metal cam lock	\$4.98 ea. \$4.16 ea. /box of 50
•			3001-25 59 black, 65 brown, 90 silver +10% Regular Duty Ceiling Bracket	\$1.24 ea. \$1.02 ea. /box of 100	•			53507-25 Ceiling Bracket w/ metal cam lock	\$1.54 ea. \$1.28 ea. /box of 100
•			3003-25 59 black, 65 brown, 90 silver +10% Heavy Duty Ceiling Bracket w/ Smart Klick	\$2.10 ea. \$1.75 ea. /box of 100	•				
•			30031-25 59 black, 65 brown, 90 silver +10% Ceiling Bracket Cover use with 3003-XX	\$0.87 ea. \$0.73 ea. /box of 100	•				

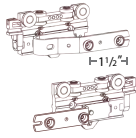
BREAK PACK PRICING - Prices with this designation indicate a 20% up charge for broken pack quantities.

# TRACKS

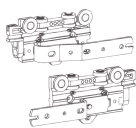
CS | CL | CM | CCS | RTS | KS | DS | DSXL | DSXL LED | RBS | RBS XL | PS | BENDS & CURVES | BATONS | WORKROOM & FES











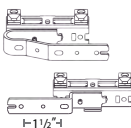

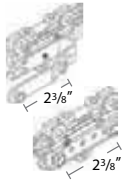





TRACKS CS CL CM

CS	CL	CM	COMPONENT	PRICE	CS	CL	CM	COMPONENT	PRICE
•	•	•	 <p>Wheeled Connected Snap Carrier in plastic sleeve  <b>2107-25, 59</b> black                      60% fullness, 2 5/8" OC  <b>2106-25, 59</b> black, <b>90</b> silver                      80% fullness, 2 3/8" OC  <b>2105-25, 24</b> gold, <b>59</b> black, <b>65</b> brown, <b>90</b> silver                      100% fullness, 2 1/8" OC  <b>2108-25, 59</b> black                      120% fullness, 1 7/8" OC</p>	\$1.46 ea.  \$1.20 ea. /roll of 500  Colors other than white +10%	•	•	•	 <p><b>52003-25</b>  <b>65</b> brown + 10%                      Economy Slide</p>	\$0.28 ea.  \$0.23 /box of 2000
•	•	•	 <p><b>52100-25, 24</b> gold, <b>59</b> black, <b>65</b> brown, <b>90</b> silver                      Ball Bearing Carrier w/ Stainless Hook                      slim line - use w/ grommets</p>	\$1.78 ea.  \$1.48 ea. /box of 1000	•	•	•	 <p><b>52005-25</b>                      Button Slide Carrier</p>	\$0.22 ea.  \$0.19 ea. /box of 1000
•	•	•	 <p><b>52105-25</b>                      Button Slide Carrier w/ Hook</p>	\$0.69 ea.  \$0.58 ea. /box of 500	•	•	•	 <p><b>52502-25</b> Overlap R  <b>52504-25</b> Underlap L  <b>59</b> black + 10%                      Standard Multi-Functional Master                      Use stiffener w/ exposed baton or hooks w/ hidden baton</p>	\$6.98 ea.  \$5.82 ea. /box of 100
•	•	•	 <p><b>52002-25</b>  <b>24</b> gold, <b>59</b> black, <b>65</b> brown, <b>90</b> silver + 10%                      Slim Line Ball Bearing Carrier</p>	\$0.65 ea.  \$0.53 ea. /box of 1000	•	•	•	 <p><b>52502-25A</b> Overlap R  <b>52504-25A</b> Underlap L  <b>59A</b> black + 10%                      Standard Multi-Functional Master w/ snaps and baton adaptor</p>	\$8.46 ea.  \$7.06 ea. /box of 100
•	•	•	 <p><b>52008-25</b>  <b>59</b> black, <b>65</b> brown + 10%                      Slim Line Klick Carrier                      draperies hang to conceal track</p>	\$1.03 ea.  \$0.86 ea. /box of 250	•	•	•	 <p><b>52502-25B</b> Overlap R  <b>52504-25B</b> Underlap L                      Standard Multi-Functional w/ baton adaptor for stiffener</p>	\$6.98 ea.  \$5.82 ea. /box of 50
•	•	•	 <p><b>52108-25</b>  <b>59</b> black + 10%                      Stop Carrier                      prevents slide back</p>	\$2.10 ea.  \$1.75 ea. /box of 100					

 BREAK PACK PRICING  - Prices with this designation indicate a 20% up charge for broken pack quantities.

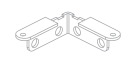
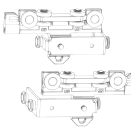
# TRACKS

CS | CL | CM | CCS | RTS | KS | DS | DSXL | DSXL LED | RBS | RBS XL | PS | BENDS & CURVES | BATONS | WORKROOM & FES

CS	CL	CM	COMPONENT	PRICE	CS	CL	CM	COMPONENT	PRICE
•	•	•	 <p><b>52508-25</b> Overlap R <b>52509-25</b> Underlap L 59 black, 65 brown + 10% Swivel Foot Multi-Functional Master for bends and curves</p>	\$12.31 ea.  \$10.27 ea. /box of 100	•	•	•	 <p><b>52601-25A</b> Overlap R <b>52603-25A</b> Underlap L Extended Spacing Master w/ snaps and adaptor</p>	\$5.65 ea.  \$4.71 ea. /box of 100
•	•	•	 <p><b>52508-25A</b> Overlap R <b>52509-25A</b> Underlap L 59 black, 65 brown + 10% Swivel Foot Multi-Functional Master w/ snaps</p>	\$14.59 ea.  \$12.16 ea. /box of 100	•	•	•	 <p><b>2552-25</b> 6" Extension Arm for master Use w/ two one-way draws</p>	\$11.44 ea.  \$9.54 ea. /box of 50
•	•	•	 <p><b>52501-25</b> Overlap R <b>52503-25</b> Underlap L Stiffener Master</p>	\$6.98 ea.  \$5.82 ea./box of 50	•	•	•	 <p><b>2551-25</b> Small Extension Arm</p>	\$4.16 ea.  \$3.45 ea. /box of 50
•	•	•	 <p><b>52401-25</b> Overlap R <b>52403-25</b> Underlap L Stiffener Master w/ snaps and adaptor</p>	\$8.56 ea.  \$7.13 ea. /box of 50	•	•	•	 <p><b>2305-25</b> 59 black, 65 brown, 90 silver + 10% Twist On End Stop</p>	\$2.10 ea.  \$1.75 ea. /box of 100
•	•	•	 <p><b>52410-25</b> Butt R <b>52409-25</b> Butt L -59 Black + 10% Standard Butt Master w/ snaps and for baton use</p>	\$16.96 ea.  \$14.12 ea. /box of 50	•	•	•	 <p><b>2308-25</b> Return Plate reversible, 2 1/2" return</p>	\$7.92 ea.  \$6.61 ea. /box of 100
•	•	•	 <p><b>52411-25A</b> Butt R <b>52412-25A</b> Butt L 24A gold, 59A black, 65A brown, 90A silver + 10% Wheeled Butt Master w/snap adaptor Designed for hidden baton</p>	\$29.94 ea.  \$24.94 ea. /box of 50	•	•	•	 <p><b>52307-90</b> End Lock</p>	\$0.93 ea.  \$0.78 ea. /box of 100
•	•	•	 <p><b>52514-25</b> Overhead R <b>52515-25</b> Underhead L Over the Top Baton Master Designed for exposed baton</p>	\$11.37 ea.  \$9.47 ea. /box of 100	•	•	•	 <p><b>54110-25</b> 36" Fiberglass Baton w/ snap</p>	\$7.34 ea.  \$6.12 ea. /box of 100 See all batons p. 23

 BREAK PACK PRICING  - Prices with this designation indicate a 20% up charge for broken pack quantities.

TRACKS CS CL CM

# TRACKS

CS | CL | CM | **CCS** | RTS | KS | DS | DSXL | DSXL LED | RBS | RBS XL | PS | BENDS & CURVES | BATONS | WORKROOM & FES



Scan for more information on the FOREST CCS Contract Cord System

## CCS® CONTRACT CORD SYSTEM

- Aluminum extrusion, powder coated and lubricated with a patented process.
- Maximum weight is 4 lbs/ft.
- Bendable – CCS Track can be bent and curved. An exact size template is required. See pages 21-22 for more information.
- Cord draw, one or two way. Bead chain also available.
- Stackback: Ripplefold - 6" per width, pinchpleat - 7" per width, accordiafold - 5" per width.
- All Forest corded products include a child safety tension device and warning label.

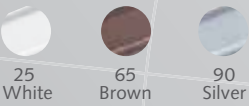







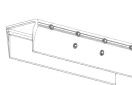

### ASSEMBLED PRICING

Includes track, masters, pinchpleat or ripplefold carriers, brackets, cord, tension pulley, child safety device. Freight is additional.

CCS CONTRACT SYSTEM	first 4 feet	ea. add'l foot
White	\$194.68	\$16.60
Brown, Silver	\$214.15	\$18.26

















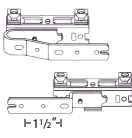
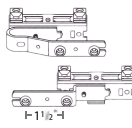

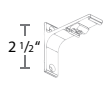

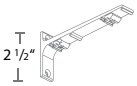
TRACKS CCS



CCS	COMPONENT	PRICE
•	 <p>CCS Contract Cord Track 20 tracks/bundle 51116-25 white 16' 51116-65 brown 16' 51116-90 silver 16'</p>	<p>\$4.82/ft. \$5.30/ft. \$5.30/ft.</p>
•	 <p>3906-25 59 black, 65 brown, 90 silver +10% Track Connector</p>	<p>\$16.16 ea. 10/box</p>
•	 <p>52801-25 65 brown, 90 silver +10% End Pulley, 2 1/4" Reversible Use on right or left</p>	<p>\$10.72 ea.  \$8.93 ea. /box 25</p>

CCS	COMPONENT	PRICE
•	 <p>52801-25A Right 52801-25B Left End Pulley w/ Snap 2 1/4 Reversible, for Ripplefold</p>	<p>\$11.66 ea.  \$9.71 ea. /box 25</p>
•	 <p>52803-25 65 brown, 90 silver +10% Small End Pulley 1 1/2" Reversible, use with Butt Masters and one-way draw</p>	<p>\$10.72 ea.  \$8.93 ea. /box 25</p>
•	 <p>3001-25 59 black, 65 brown, 90 silver +10% Regular Duty Ceiling Bracket</p>	<p>\$10.72 ea.  \$1.02 ea. /box of 100</p>

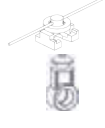
# TRACKS

CS | CL | CM | **CCS** | RTS | KS | DS | DSXL | DSXL LED | RBS | RBS XL | PS | BENDS & CURVES | BATONS | WORKROOM & FES

CCS	COMPONENT	PRICE	CCS	COMPONENT	PRICE
●	 <p><b>3003-25</b> 59 black, 65 brown, 90 silver +10% Heavy Duty Ceiling Bracket w/ Smart Klick</p>	\$2.10 ea.  \$1.75 ea. /box of 100	●	 <p><b>52008-25</b> 59 black, 65 brown + 10% Slim Line Klick Carrier draperies hang to conceal track</p>	\$1.03 ea.  \$0.86 ea. /box of 250
●	 <p><b>30031-25</b> 59 black, 65 brown, 90 silver +10% Ceiling Bracket Cover use with 3003-XX</p>	\$0.87 ea.  \$0.73 ea. /box of 100	●	 <p><b>52004-25</b> Low Profile Ball Bearing</p>	\$1.46 ea.  \$1.20 ea. /box of 1000
●	 <p><b>53202-25</b> 59 black, 65 brown, 90 silver +10% 3" Smart Klick Wall Bracket w/ wide base, adjusts 3-4.5"</p>	\$3.10 ea.  \$2.59 ea. /box of 100	●	 <p><b>52508-25</b> Overlap R <b>52509-25</b> Underlap L 59 black, 65 brown + 10% Swivel Foot Multi-Functional Master for bends and curves</p>	\$12.31 ea.  \$10.27 ea. /box of 100
●	 <p><b>53206-25</b> 59 black, 65 brown, 90 silver +10% 6" Smart Klick Double Wall Bracket w/ wide base adjusts 2.5"-4" &amp; 6"-7.5"</p>	\$5.10 ea.  \$4.24 ea. /box of 50	●	 <p><b>52508-25A</b> Overlap R <b>52509-25A</b> Underlap L 59 black, 65 brown + 10% Swivel Foot Multi-Functional Master w/ snaps</p>	\$14.59 ea.  \$12.16 ea. /box of 100
●	 <p><b>3280-25</b> 59 black, 65 brown, 90 silver +10% 3" Wall Bracket, heavy duty projection 2 1/2"</p>	\$11.57 ea.  \$9.64 ea. /box of 20	●	 <p><b>52411-25A</b> Butt R <b>52412-25A</b> Butt L 24A gold, 59A black, 65A brown, 90A silver + 10% Wheeled Butt Master w/snap adaptor Designed for hidden baton</p>	\$29.94 ea.  \$24.94 ea. /box of 50
●	 <p><b>3281-25</b> 59 black, 65 brown +10% 6" Double Wall Bracket, heavy duty projection 1 1/2", 5 1/2"</p>	\$16.58 ea.  \$13.82 ea. /box of 15	●	 <p><b>52804-25</b> CCS Return Insert with snap or hook</p>	\$5.81 ea.  \$4.85 ea. /box of 25
●	 <p><b>32801-25</b> 59 black, 90 silver +10% Wall Bracket Cover use with 3280 &amp; 3281</p>	\$2.98 ea.  \$2.49 ea. /box of 50	●	 <p><b>52510-25</b> 65 brown +10% Cord Connector</p>	\$2.27 ea.  \$1.89 ea. /box of 100
●	 <p><b>3001-25</b> 59 black, 65 brown, 90 silver +10% Regular Duty Ceiling Bracket</p>	\$1.24 ea.  \$1.02 ea. /box of 100	●	 <p><b>2305-25</b> 65 brown, 90 silver +10% Twist On End Stop use with curved tracks</p>	\$2.10 ea.  \$1.75 ea. /box of 100
●	 <p>Two Piece Connected Snap Carrier w/ Square Base, in plastic sleeve. Use 1 1/4" snap tape <b>2114-25</b>, 59 black 60% fullness, 2 5/8" OC <b>2111-25</b>, 65 brown, 90 silver 80% fullness, 2 3/8" OC <b>2112-25</b>, 59 black 100% fullness, 2 1/8" OC <b>2115-25</b>, 59 black 120% fullness, 1 7/8" OC</p>	\$1.17 ea.  \$0.97 ea. /roll of 500  Colors other than white +10%	●	 <p><b>9004-25</b> 3.2mm Cord 273.4 yds./roll</p>	\$1.95/yd.  \$1.62/yd. for 273.4 yards
			●	 <p><b>49501-25</b> Tension Device For child safety</p>	\$8.19 ea.  \$6.81 ea. /box of 250

 BREAK PACK PRICING  - Prices with this designation indicate a 20% up charge for broken pack quantities.

# TRACKS

CS | CL | CM | CCS | **RTS** | KS | DS | DSXL | DSXL LED | RBS | RBS XL | PS | BENDS & CURVES | BATONS | WORKROOM & FES

TRACKS RECESSED



Scan for more information on the FOREST RTS Recessed Track System



25  
White



**MOTOR CONTROL**  
P. 75-76

## RTS RECESSED TRACK SYSTEM

- Heavy duty aluminum extrusion, white, powder coated and lubricated with a patented process.
- Maximum weight is 8 lbs/ft.
- Hand or baton draw, one or two way.
- Stackback: Ripplefold - 6" per width, pinchpleat - 7" per width, cubicle - 5" per width.

### ASSEMBLED PRICING

Includes track, masters, pinchpleat or ripplefold carriers, recess profile, fixing strip, wedge, and 36" white fiberglass baton (See all batons page 23). Freight is additional.

RTS RECESSED TRACK	first 4 feet	ea. add'l foot
White	\$207.80	\$27.23





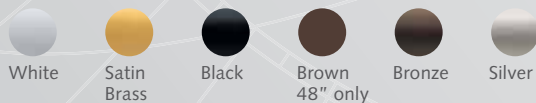





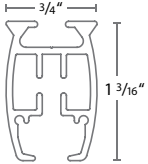
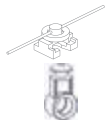





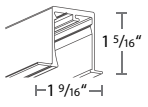

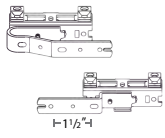

### BATON OPTIONS

Fiberglass batons in 36", 48", 60" and 72" lengths and these colors. See all batons page 23.

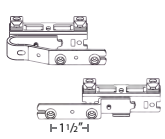

# TRACKS

CS | CL | CM | CCS | **RTS** | KS | DS | DSXL | DSXL LED | RBS | RBS XL | PS | BENDS & CURVES | BATONS | WORKROOM & FES

RTS	COMPONENT	PRICE	RTS	COMPONENT	PRICE
●	 <p><b>51623-25</b> RTS Track white 23' x 10 tracks/bundle bundle = 230'</p>	\$11.79/ft.	●	 <p>Two Piece Connected Snap Carrier w/ Square Base, in plastic sleeve. Use 1 1/4" snap tape <b>2114-25, 59</b> black 60% fullness, 2 5/8" OC <b>2111-25, 65</b> brown, <b>90</b> silver 80% fullness, 2 3/8" OC <b>2112-25, 59</b> black 100% fullness, 2 1/8" OC <b>2115-25, 59</b> black 120% fullness, 1 7/8" OC</p>	\$1.17 ea.  \$0.97 ea. /roll of 500 Colors other than white +10%
●	 <p><b>3803-25</b> Track Connector</p>	\$10.24 ea.  \$8.53 ea./box of 100	●	 <p><b>52008-25</b> Slim Line Klick Carrier Allows drapery to hang and conceal track</p>	\$1.03 ea.  \$0.86 ea./box of 250
●	 <p><b>51723-25</b> Recess Profile, 23' Order same length as track</p>	\$15.59/ft.	●	 <p><b>52009-25</b> Ball Bearing Carrier for motorization</p>	\$1.46 ea.  \$1.20 ea./box of 250
●	 <p><b>51724-25</b> Recess Profile Fixing Strip, 23' Order 6" shorter than track</p>	\$3.28/ft.	●	 <p><b>52508-25</b> Overlap R <b>52509-25</b> Underlap L Swivel Foot Multi-Functional Master</p>	\$12.31 ea.  \$10.27 ea./box of 100
●	 <p><b>53914-25</b> Recess Profile Wedge Order 1 per track</p>	\$4.59 ea.  \$3.82 ea./box of 10	●	 <p><b>52508-25A</b> Overlap R <b>52509-25A</b> Underlap L Swivel Foot Multi-Functional Master w/ snaps</p>	\$14.59 ea.  \$12.16 ea./box of 100
●	 <p><b>3801-25</b> RTS End Cap</p>	\$6.08 ea.  \$5.07 ea./box of 200	●	 <p><b>52410-25</b> Butt R <b>52409-25</b> Butt L Standard Butt Master w/ 3 snaps for baton use</p>	\$16.96 ea.  \$14.12 ea./box of 50

 BREAK PACK PRICING  - Prices with this designation indicate a 20% up charge for broken pack quantities.

TRACKS RECESSED

# TRACKS

CS | CL | CM | CCS | RTS | **KS** | **DS** | DSXL | DSXL LED | RBS | RBS XL | PS | BENDS & CURVES | BATONS | WORKROOM & FES



Scan for more information on the FOREST Track Systems

## KS® KLICK SYSTEM DS® DESIGN SYSTEM

- Aluminum extrusion, powder coated and lubricated with a patented process.
- Maximum weight is 3 lbs/ft.
- Bendable – KS Track can be bent and curved. An exact size template is required. See pages 23-24 for more information.
- Hand or baton draw, one or two way.
- Stackback: ripplefold - 6" per width, pinchpleat - 7" per width, cubicle - 5" per width, accordiafold - 5" per width.

### ASSEMBLED PRICING

Includes track, masters, pinchpleat or ripplefold carriers, brackets, and 36" white fiberglass baton (See all batons page 23). Freight is additional.







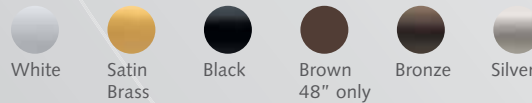

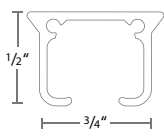

	first 4 feet	ea. add'l foot
KS Track White	\$108.93	\$12.66
KS Track Black, Brown, Silver	\$119.82	\$13.93
DS Track White only	\$111.72	\$12.06

### BATON OPTIONS

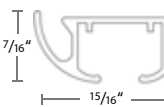
Fiberglass batons in 36", 48", 60" and 72" lengths and these colors. See all batons page 23.



TRACKS KS DS

KS	DS	COMPONENT	PRICE	KS	DS	COMPONENT	PRICE
•		 <p>KS Klick System Track  <b>1013-25</b> white 13' 1"  <b>1016-25</b> white 16' 4"  <b>1019-25</b> white 19' 8"</p> <p>\$3.82/ft. 20 tracks /bundle</p> <p><b>1016-59</b> black 16' 4"  <b>1016-65</b> brown 16' 4"  <b>1016-90</b> silver 16' 4"</p> <p>\$4.15/ft. 20 tracks /bundle</p>		•		 <p><b>2309-25</b>  <b>59</b> black , <b>65</b> brown,  <b>90</b> silver +10%                      KS End Cap Multifunctional</p> <p>\$1.18 ea.                       \$0.98 ea. /box of 100</p>	
		<p><b>1016-59</b> black 16' 4"  <b>1016-65</b> brown 16' 4"  <b>1016-90</b> silver 16' 4"</p> <p>\$4.15/ft. 20 tracks /bundle</p>		•		 <p><b>2310-25</b>                      DS End Cap w/ screw</p> <p>\$2.01 ea.                       \$1.68 ea. /box of 10</p>	
		 <p>DS Design System Track  <b>1116-25</b> white 16' 4"</p> <p>\$5.91/ft. 20 tracks /bundle</p>		•	•	 <p><b>3001-25</b>  <b>59</b> black , <b>65</b> brown,  <b>90</b> silver +10%                      Regular Duty Ceiling Bracket</p> <p>\$1.24 ea.                       \$1.02 ea. /box of 100</p>	
•	•	 <p><b>3905-25</b>  <b>59</b> black , <b>65</b> brown,  <b>90</b> silver +10%                      Track Connector                      + key <b>3904-00</b></p> <p>\$9.56 ea.                       \$7.97 ea. /box 50</p>		•	•	 <p><b>3901-25</b>  <b>59</b> black , <b>65</b> brown,  <b>90</b> silver +10%                      Ceiling Splice/Bracket</p> <p>\$2.10 ea.                       \$1.75 ea. /box of 50</p>	

 BREAK PACK PRICING  - Prices with this designation indicate a 20% up charge for broken pack quantities.



# TRACKS

CS | CL | CM | CCS | RTS | **KS** | **DS** | DSXL | DSXL LED | RBS | RBS XL | PS | BENDS & CURVES | BATONS | WORKROOM & FES

KS	DS	COMPONENT	PRICE	KS	DS	COMPONENT	PRICE
•	•	 <b>3003-25</b> 59 black , 65 brown, 90 silver +10% Heavy Duty Ceiling Bracket w/ Smart Klick	\$2.10 ea. \$1.75 ea. /box of 100	•	•	 <b>52003-25</b> 65 brown +10% Economy Slide	\$0.28 ea. \$0.23 /box of 2000
•	•	 <b>30031-25</b> 59 black , 65 brown, 90 silver +10% Ceiling Bracket Cover use with 3003-XX	\$0.87 ea. \$0.73 ea. /box of 100	•	•	 <b>52004-25</b> Low Profile Ball Bearing Carrier	\$1.46 ea. \$1.20 ea. /box of 1000
•	•	 <b>53202-25</b> 59 black , 65 brown, 90 silver +10% 3" Smart Klick Wall Bracket w/ wide base, adjusts 3-4.5"	\$3.10 ea. \$2.59 ea. /box of 100	•	•	 <b>2201-25</b> 59 black , 65 brown +10% Klick Carrier w/ Stainless Hook Use with grommets	\$1.41 ea. \$1.17 ea. /box of 100
•	•	 <b>53206-25</b> 59 black , 65 brown, 90 silver +10% 6" Smart Klick Double Wall Bracket w/ wide base adjusts 2.5"-4" & 6"-7.5"	\$5.10 ea. \$4.24 ea. /box of 50	•	•	 <b>52005-25</b> Button Slide Carrier	\$0.22 ea. \$0.19 ea. /box of 1000
•	•	 <b>3280-25</b> 59 black , 65 brown, 90 silver +10% 3" Wall Bracket, heavy duty projection 2 1/2"	\$11.57 ea. \$9.64 ea. /box of 20	•	•	 <b>52105-25</b> Button Slide Carrier w/ Hook	\$0.69 ea. \$0.58 ea. /bag of 500
•	•	 <b>3281-25</b> 59 black , 65 brown +10% 6" Double Wall Bracket, heavy duty projection 1 1/2" , 5 1/2"	\$16.58 ea. \$13.82 ea. /box of 15	•	•	 <b>2525-25</b> Overlap R <b>2526-25</b> Underlap L 59 black , 65 brown +10% Pinchpleat Master <b>2527-25</b> Overlap L <b>2528-25</b> Underlap R	\$12.26 ea. \$10.21 ea. /box of 25
•	•	 <b>32801-25</b> 59 black, 90 silver +10% Wall Bracket Cover use with 3280 & 3281	\$2.98 ea. \$2.49 ea. /box of 50	•	•	 <b>52410-25</b> Butt R <b>52409-25</b> Butt L 59 black +10% Standard Butt Master w/ snaps and for baton use	\$16.96 ea. \$14.12 ea. /box of 100
•	•	 <b>2001-25</b> 59 black , 65 brown, 90 silver +10% Klick Carrier, for pinch pleat	\$0.53 ea. \$0.45 ea. /box of 500	•	•	 <b>2540-25</b> Overlap R <b>2541-25</b> Underlap L Low Profile Snap Master for straight track only	\$6.98 ea. \$5.82 ea. /box of 100
•	•	 <b>2002-25</b> 59 black , 65 brown, 90 silver +10% Shirrtape Carrier	\$0.51 ea. \$0.43 ea. /box of 500	•	•	 <b>2305-25</b> 59 black , 65 brown, 90 silver +10% Twist On End Stop	\$2.10 ea. \$1.75 ea. /box of 100
•	•	 <b>2004-25</b> 59 black +10% Snap Carrier, for accordiafold	\$0.53 ea. \$0.45 ea. /box of 500	•	•	 <b>52307-90</b> End Lock	\$0.93 ea. \$0.78 ea. /box of 100
•	•	Two Piece Connected Snap Carrier w/ Square Base, in plastic sleeve. Use 1 1/4" snap tape <b>2114-25</b> , 59 black 60% fullness, 2 5/8" OC <b>2111-25</b> , 65 brown, 90 silver 80% fullness, 2 3/8" OC <b>2112-25</b> , 59 black 100% fullness, 2 1/8" OC <b>2115-25</b> , 59 black 120% fullness, 1 7/8" OC	\$1.17 ea. \$0.97 ea. /roll of 500  Colors other than white +10%	•	•	 <b>2308-25</b> Return Plate reversible, 2 1/2" return	\$7.92 ea. \$6.61 ea. /box of 100
•	•	 <b>54110-25</b> 36" Fiberglass Baton w/ snap	\$7.34 ea. \$6.12 ea. /box of 100	•	•	 <b>54110-25</b> 36" Fiberglass Baton w/ snap	\$7.34 ea. \$6.12 ea. /box of 100

See all batons p. 23

# TRACKS

CS | CL | CM | CCS | RTS | KS | DS | **DSXL** | **DSXL LED** | RBS | RBS XL | PS | BENDS & CURVES | BATONS | WORKROOM & FES

TRACKS DSXL / DSXL LED



Scan for more information on the FOREST DSXL Design System XL



25  
White



**MOTOR CONTROL**  
P. 77-78

## DSXL® DESIGN SYSTEM DSXL® LED DESIGN SYSTEM + LED LIGHTING

- Elegantly shaped aluminum extrusion, white, powder coated and lubricated with a patented process. LED lighting lights up the backside of drapery or the track itself.
- LED strips have low energy consumption, are eco-friendly, dimmable. Lifespan is 30,000 hours.
- Maximum weight is 3 lbs/ft.
- Hand or baton draw, one or two way. DSXL LED can also be motorized. See pages 73-74.
- Stackback: Ripplefold - 6" per width, pinchpleat - 7" per width, cubicle - 5" per width, accordiafold - 5" per width.

### ASSEMBLED PRICING

Includes track, masters, pinchpleat or ripplefold carriers, wall or ceiling brackets, lighting components (if specified), and 36" white fiberglass baton (See all batons page 23). Freight is additional.

DESIGN SYSTEM XL	first 4 feet	ea. add'l foot
DSXL	\$237.76	\$32.87
DSXL LED	\$1,766.87	\$103.32





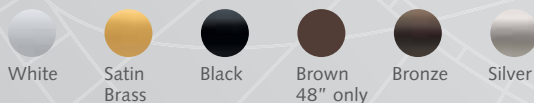





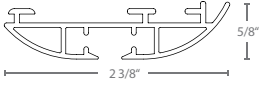

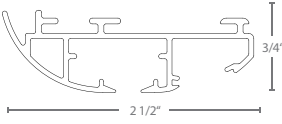







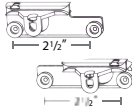



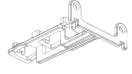

### BATON OPTIONS

Fiberglass batons in 36", 48", 60" and 72" lengths and these colors. See all batons page 23.



# TRACKS

CS | CL | CM | CCS | RTS | KS | DS | **DSXL** | **DSXL LED** | RBS | RBS XL | PS | BENDS & CURVES | BATONS | WORKROOM & FES

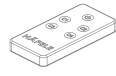
DSXL	DSXL LED	COMPONENT	PRICE	DSXL	DSXL LED	COMPONENT	PRICE
●		 <p><b>2119-25</b> DSXL Track white 19' 8" x 20 tracks per bundle bundle = 393.7'</p>	\$12.71/ft.	●	●	 <p>Two Piece Connected Snap Carrier w/ Square Base, in plastic sleeve. Use 1 1/4" snap tape <b>2114-25, 59</b> black 60% fullness, 2 5/8" OC <b>2111-25, 65</b> brown, <b>90</b> silver 80% fullness, 2 3/8" OC <b>2112-25, 59</b> black 100% fullness, 2 1/8" OC <b>2115-25, 59</b> black 120% fullness, 1 7/8" OC</p>	\$1.17 ea.  \$0.97 ea. /roll of 500  Colors other than white +10%
●		 <p><b>3119-25</b> DSXL Track white 19' 8" x 20 tracks per bundle bundle = 393.7'</p>	\$13.79/ft.	●	●	 <p><b>2001-25</b> Klick Carrier for PP</p>	\$0.53 ea.  \$0.45 ea. /box of 500
●	●	 <p><b>2311-25</b> Track Connector</p>	\$13.44 ea.  \$11.20 ea. /box of 15	●	●	 <p><b>2201-25</b> Klick Carrier w/ Hook</p>	\$1.41 ea.  \$1.17 ea. /box of 100
●		 <p><b>2400-25</b> DSXL End Cap</p>	\$2.29 ea.  \$1.92 ea. /box of 20	●	●	 <p><b>2540-25</b> Overlap R <b>2541-25</b> Underlap L Low Profile Snap Master</p>	\$6.98 ea.  \$5.82 ea. /box of 100
●		 <p><b>3400-25</b> DSXL LED End Cap</p>	\$2.08 ea.  \$1.74 ea. /box of 20	●	●	 <p><b>9040-25</b> FES Butt Master</p>	\$4.94 ea.  \$4.11 ea. /box of 25
●		 <p><b>3402-25</b> DSXL LED Flat End Cap</p>	\$2.08 ea.  \$1.74 ea. /box of 20	●		 <p><b>3000-00</b> LED Strip, 3000k/24v 30,000 hr lifespan Dimmable</p>	\$1,433.41 ea. /19' strip \$75.44/ft.
●	●	 <p><b>3801-25</b> DSXL Swivel Ceiling Bracket</p>	\$6.08 ea.  \$5.07 ea. /box of 100	●		 <p><b>3100-00</b> Connector Cable For LED Strip</p>	\$25.37 ea. 1/box
●	●	 <p><b>2301-25</b> DSXL Wall Bracket w/ Swivel</p>	\$40.72 ea.  \$33.94 ea. /box of 5	●		 <p>Power Transformer <b>3101-25</b> 40w, 24v <b>3102-25</b> 90w, 24v</p>	\$263.00 ea. \$601.12 ea. 1/box
		 <b>BREAK PACK PRICING</b>  - Prices with this designation indicate a 20% up charge for broken pack quantities.		●		 <p><b>3121-59</b> Dimmer Remote Control 4 Channel</p>	\$157.79 ea. 1/box

TRACKS DSXL / DSXL LED

# TRACKS

CS | CL | CM | CCS | RTS | KS | DS | DSXL | DSXL LED | **RBS** | RBS XL | PS | BENDS & CURVES | BATONS | WORKROOM & FES



TRACKS RBS



Scan for more information on the FOREST RBS Roman Blind System



25  
White

## RBS ROMAN BLIND SYSTEM

- The most durable and functional roman blind system on the market. RBS includes integrated Velcro tape so the fabric can be easily attached and removed.
- Aluminum, white, powder coated extrusion. Best suited for light to medium weight fabrics in contract or residential applications.
- Maximum weights:
  - 1:4 gear up to 18 lbs.
  - 1:2 gear up to 14 lbs.
  - 1:1 gear up to 10 lbs.
- Includes child safety device and warning label. A motorized option is also available on page 79.

### ASSEMBLED PRICING

Includes headrail, cord roll supports, wall or ceiling brackets, counterweight (if requested), Velcro profile, chain, child safety tension device & warning label. When ordering, please specify chain drop length, wall or ceiling mount, control side, and number of cord roll supports needed. Freight is additional.











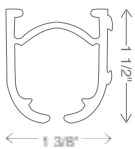

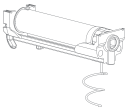
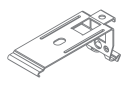
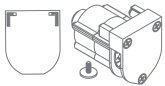

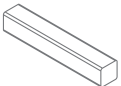

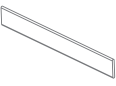

RBS ROMAN BLIND SYSTEM	first 4 feet	ea. add'l inch
White	\$126.44	\$2.67

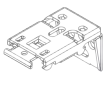

**MOTOR CONTROL**  
P. 79-80

# TRACKS

CS | CL | CM | CCS | RTS | KS | DS | DSXL | DSXL LED | **RBS** | RBS XL | PS | BENDS & CURVES | BATONS | WORKROOM & FES

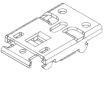
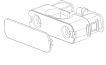
RBS	COMPONENT	PRICE	RBS	COMPONENT	PRICE
●	 <b>41019-25</b> RBS Headrail 19' x 10 rails/bundle bundle = 190'	\$7.29/ft.	●	 <b>49008-00</b> Shade Leveler	\$0.53 ea. \$0.45 ea. /box of 1000
●	 <b>49010-25</b> RBS Cord Roll Support w/ quick lock, 12' drop	\$6.98 ea. \$6.34 ea. /box of 100	●	 <b>49090-25</b> Valance Bracket attaches to velcro profile	\$2.84 ea. \$2.37 ea. /box of 50
●	 Control Unit w/ End Cap & Retaining Ring heavy duty, self-braking <b>42311-25</b> 1:4 gear to 18 lbs. <b>42312-25</b> 1:2 gear to 14 lbs. <b>42310-25</b> 1:1 gear to 10 lbs.	\$16.24 ea. \$13.53 ea. /box of 100	●	 <b>49091-25</b> Valance Corners	\$4.13 ea. \$3.44 ea. /box of 250
●	 <b>41119-90</b> 19' Rod aluminum 3/16" x 3/16"	\$2.58/ft. \$2.15/ft. /bundle of 5	●	 <b>39007-25</b> Velcro Tape 27 yds. per roll	\$27.14/roll
●	 <b>49005-25</b> Counterweight, 19' aluminum 1" x 1/8"	\$2.38/ft. \$1.90/ft. /bundle of 20	●	 <b>49006-25</b> Fiberglass Spines, 19' 3/16" diameter	\$0.50/ft. \$0.43/ft. /bundle of 250
●	 <b>31116-25</b> Velcro Profile w/ Hook Tape, 13.1'	\$4.53/ft. \$3.78/ft. /bundle of 20	●	 <b>49014-25</b> Plastic Snap Ring	\$0.12 ea. \$0.09 ea. /box of 5000
●	 <b>43202-25</b> Swivel Wall Bracket	\$2.19 ea. \$1.82 ea. /box of 100	●	 <b>49013-25</b> Plastic Ring Cord Guide	\$0.12 ea. \$0.09 ea. /box of 5000
●	 <b>43003-25</b> Swivel Ceiling Bracket	\$2.47 ea. \$2.06 ea. /box of 100	●	 <b>49400-25</b> Shroud 73 yds. per roll	\$282.00/roll
●	 <b>43033-25</b> Klick Wall Bracket	\$2.47 ea. \$2.06 ea. /box of 200	●	 Endless Chain, white <b>90</b> Nickel (29"-69"), <b>95</b> Beige, <b>99</b> Ivory +10% Drop lengths available: <b>49020-25</b> 29" \$2.14 ea. <b>49021-25</b> 39" \$2.48 ea. <b>49022-25</b> 49" \$3.07 ea. <b>49023-25</b> 59" \$3.41 ea. <b>49024-25</b> 69" \$3.59 ea. <b>49025-25</b> 79" \$3.70 ea <b>49026-25</b> 89" \$3.83 ea <b>49027-25</b> 99" \$4.15 ea	See center column for pricing
●	 <b>43034-25</b> Hidden Klick Multi Bracket	\$2.47 ea. \$2.06 ea. /box of 100	●	 <b>76047-90</b> Metal Ball Chain Stopper	\$0.53 ea.
●	 <b>43004-25</b> Klick Ceiling Bracket	\$2.47 ea. \$2.06 ea./ box of 100	●	 <b>49501-00</b> Tension Device For child safety	\$8.19 ea. \$6.81 ea. /box of 250

**BREAK PACK PRICING** - Prices with this designation indicate a 20% up charge for broken pack quantities.

# TRACKS

CS | CL | CM | CCS | RTS | KS | DS | DSXL | DSXL LED | RBS | **RBS XL** | PS | BENDS & CURVES | BATONS | WORKROOM & FES

TRACKS RBS XL ROMAN BLIND SYSTEM XL



Scan for more information on the FOREST RBS XL Roman Blind System



25  
White

## RBS XL ROMAN BLIND SYSTEM

- Aluminum, white, powder coated extrusion. Best suited for light to medium weight fabrics in contract or residential applications.
- Includes integrated Velcro tape so the fabric can be easily attached and removed.
- Maximum weight is a 1:4 gear which will pull up to 24 lbs.
- Includes child safety device and warning label.











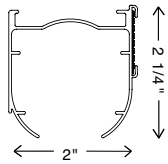

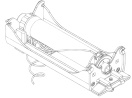

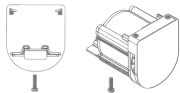

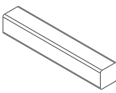
### ASSEMBLED PRICING

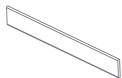
Includes headrail, cord roll supports, wall or ceiling brackets, counterweight (if requested), Velcro profile, chain, child safety tension device & warning label. When ordering, please specify chain drop length, wall or ceiling mount, control side, and number of cord roll supports needed. Freight is additional.

RBS XL ROMAN BLIND SYSTEM	first 4 feet	ea. add'l inch
White	\$153.59	\$3.39

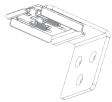
# TRACKS

CS | CL | CM | CCS | RTS | KS | DS | DSXL | DSXL LED | RBS | **RBS XL** | PS | BENDS & CURVES | BATONS | WORKROOM & FES

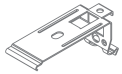
RBS XL	COMPONENT	PRICE	RBS XL	COMPONENT	PRICE
●	 <b>44019-25</b> RBS XL Headrail 19' x 10 rails/bundle bundle = 190'	\$10.75/ft.	●	 <b>49091-25</b> Valance Corners	\$4.13 ea. \$3.44 ea. /box of 250
●	 <b>44003-25</b> RBS XL Cord Roll Support	\$7.90 ea. \$6.58 ea. /box of 100	●	 <b>39007-25</b> Velcro Tape 27 yds. per roll	\$27.14/roll
●	 <b>44311-25</b> RBS XL Control Unit w/ End Cap & Screw 1:4 gear to 24 lbs.	\$22.58 ea. \$18.81 ea. /box of 100	●	 <b>49006-25</b> Fiberglass Spines, 19' 3/16" diameter	\$0.50/ft. \$0.43/ft. /bundle of 250
●	 <b>41119-90</b> 19' Rod aluminum 3/16" x 3/16"	\$2.58/ft. \$2.15/ft. /bundle of 5	●	 <b>49014-25</b> Plastic Snap Ring	\$0.12 ea. \$0.09 ea. /box of 5000
●	 <b>49005-25</b> Counterweight, 19' aluminum 1" x 1/8"	\$2.38/ft. \$1.90/ft. /bundle of 20	●	 <b>49013-25</b> Plastic Ring Cord Guide	\$0.12 ea. \$0.09 ea. /box of 5000
●	 <b>31116-25</b> Velcro Profile w/ Hook Tape, 13.1'	\$4.53/ft. \$3.78/ft. /bundle of 20	●	 <b>49400-25</b> Shroud 73 yds. per roll	\$282.00/roll
●	 <b>44004-90</b> RBS XL Ceiling Bracket nickel plated	\$3.59 ea. \$2.99 ea. /box of 100	●	Endless Chain, white <b>90</b> Nickel (29"-69"), <b>95</b> Beige, <b>99</b> Ivory +10% Drop lengths available: <b>49020-25</b> 29" \$2.14 ea. <b>49021-25</b> 39" \$2.48 ea. <b>49022-25</b> 49" \$3.07 ea. <b>49023-25</b> 59" \$3.41 ea. <b>49024-25</b> 69" \$3.59 ea. <b>49025-25</b> 79" \$3.70 ea. <b>49026-25</b> 89" \$3.83 ea. <b>49027-25</b> 99" \$4.15 ea.	See center column for pricing'
●	 <b>44033-90</b> RBS XL Wall Bracket nickel plated	\$9.39 ea. \$7.82 ea. /box of 100	●	 <b>76047-90</b> Metal Ball Chain Stopper	\$0.53 ea.
●	 <b>49008-00</b> Shade Leveler	\$0.53 ea. \$0.45 ea. /box of 1000	●	 <b>49501-25</b> Tension Device For child safety	\$8.19 ea. \$6.81 ea. /box of 250
●	 <b>49090-25</b> Valance Bracket attaches to velcro profile	\$2.84 ea. \$2.37 ea. /box of 50			

**BREAK PACK PRICING** - Prices with this designation indicate a 20% up charge for broken pack quantities.

# TRACKS

CS | CL | CM | CCS | RTS | KS | DS | DSXL | DSXL LED | RBS | RBS XL | **PS** | BENDS & CURVES | BATONS | WORKROOM & FES

TRACKS PANEL SYSTEM



Scan for more information on the FOREST PS Panel System

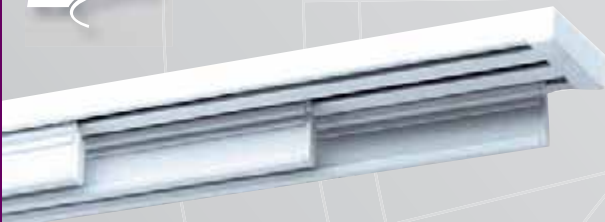

25  
White

## PS® PANEL SYSTEM

- Aluminum extrusion, powder coated.
- Maximum weight is 10 lbs/panel.
- Hand or baton draw, one or two way.
- 2, 3, 4, or 5 channel systems available.

### ASSEMBLED PRICING

Includes track, masters, pinchpleat or ripplefold carriers, brackets, cord, tension pulley, child safety device. Freight is additional.

PS PANEL SYSTEM	first 4 feet	ea. add'l foot
2 Channel	\$177.99	\$28.07
3 Channel	\$201.42	\$33.13
4 Channel	\$237.13	\$39.88
5 Channel	\$275.79	\$43.83

### BATON OPTIONS



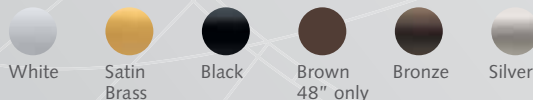

















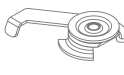

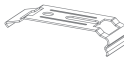









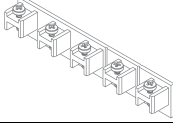



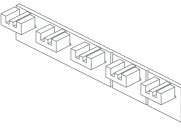



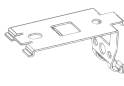



Fiberglass batons in 36", 48", 60" and 72" lengths and these colors. See all batons page 23.





# TRACKS

CS | CL | CM | CCS | RTS | KS | DS | DSXL | DSXL LED | RBS | RBS XL | **PS** | BENDS & CURVES | BATONS | WORKROOM & FES

PS	COMPONENT	PRICE	PS	COMPONENT	PRICE
●	 5/8" 1 1/2"	PS Panel System Track	●	 33204-25 L End Stop for stationary panel	\$0.60 ea.  \$0.49 ea. /box of 500
	 5/8" 2"	31219-25 2 channel \$6.04/ft.		 33209-25 Reverse L Stop for lead panel	\$0.60 ea.  \$0.49 ea. /box of 500
	 5/8" 2 3/4"	31319-25 3 channel \$7.59/ft.		 32308-25 Stationary Set Screw locks side panel in place	\$0.50 ea.  \$0.43 ea. /box of 500
	 5/8" 3 1/2"	31419-25 4 channel \$10.17/ft.		 33003-25 Swivel Ceiling Bracket for 2, 3 & 4 Channel	\$1.03 ea.  \$0.86 ea. /box of 200
	 5/8" 19' x 5 tracks/bundle bundle = 95'	31519-25 5 channel \$12.16/ft.		 Klick On Ceiling Bracket/Splice 33002-25 2, 3 & 4 Channel	\$1.30 ea.  \$1.09 ea. /box of 200
●	 32310-25 2-Channel End Cap Requires end cap cover	\$0.99 ea.  \$0.84 ea. /box of 500	 33004-25 5 Channel	\$1.97 ea.  \$1.64 ea. /box of 200	
●	 32312-25 2-Channel Cover for End Cap & Pulley	\$0.60 ea.  \$0.49 ea. /box of 600	 Wall Bracket 33005-25 2, 3 & 4 Channel	\$3.14 ea.  \$2.62 ea. /box of 200	
●	 32311-25 3, 4, 5-Channel End Cap Requires end cap cover	\$1.62 ea.  \$1.35 ea. /box of 300	 33006-25 5 Channel	\$3.85 ea.  \$3.21 ea. /box of 200	
●	 32309-25 3, 4 & 5-Channel Cover for End Cap & Pulley	\$1.03 ea.  \$0.86 ea. /box of 600	 39007-25 Velcro Tape 27 yds. per roll	\$27.14/roll	
●	 31116-25 Velcro Profile w/ Hook Tape, 13.1'	\$4.53/ft.  \$3.78/ft. for bundle of 20	 39090-25 Valance Bracket Does not fit 5-channel	\$2.87 ea.  \$2.39 ea. /box of 50	
●	 32007-25 Wheeled Carrier connects profile to track	\$1.34 ea.  \$1.12 ea. /box of 500	 49091-25 Valance Corners To connect profile returns	\$4.13 ea.  \$3.44 ea. /box of 250	
●	 32510-25 Baton Adaptor use on leading panel	\$1.25 ea.  \$1.03 ea. /box of 500	 54110-25 36" Fiberglass Baton w/ snap See all batons page 23	\$7.34 ea.  \$6.12 ea. /box of 100	
●	 33202-25 Catcher, T-Angle for all panels except stationary panel	\$0.60 ea.  \$0.49 ea. /box of 500			
●	 33203-25 Stopper, A-Angle for all but lead panel	\$0.60 ea.  \$0.49 ea. /box of 500			

 BREAK PACK PRICING  - Prices with this designation indicate a 20% up charge for broken pack quantities.

# BENDING & CURVING

CS | CL | CM | CCS | RTS | KS | DS | DSXL | DSXL LED | RBS | RBS XL | PS | **BENDS & CURVES** | BATONS | WORKROOM & FES



## CUSTOM BENDING & CURVING

- Forest will custom bend and curve our drapery hardware to your exact specifications. Or, bend and curve at your workroom with our equipment.
- All custom bend and curve orders require a template at actual size. Mail to Forest Drapery Hardware, 2500 Donn Drive, Cartersville GA 30120, Attn: Customer Service.
- Polished Chrome and wood foil finishes cannot be bent or curved. Satin Nickel and Bronze finishes may be slightly distorted at the site of the bend/curve.

### BEND/CURVE THESE SYSTEMS

Track Systems: CS on pages 3-6, CCS on pages 7-8 and KS/DS on pages 11-12

Decorative Metal H-Rail Systems: Dresden Traversing on pages 41-42, and Deventer CRS on pages 47-48

Motorized Systems: FMS on pages 73-74, Dresden on pages 83-84, and Deventer MRS on pages 89-90

### PRICING





Bends: \$20.00/bend      Minimum Charge: \$100.00  
 Curves: \$10.00/ft.      Crating Fee: \$50.00/rod  
 No discounts will be given on this pricing.

## KS/DS BENDING

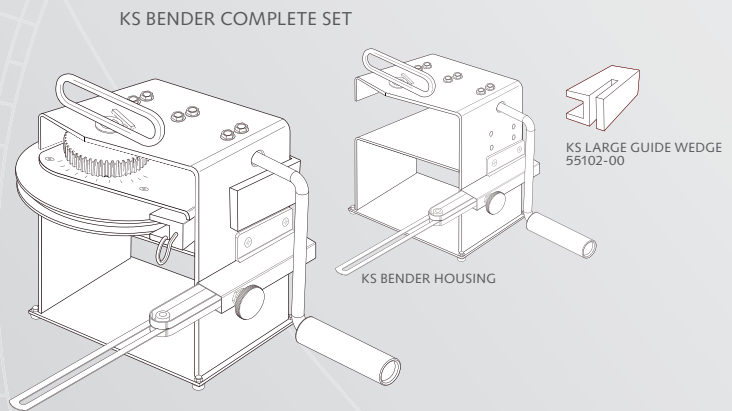
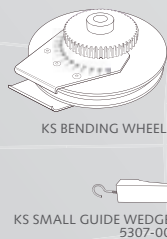
**5002-00**  
 KS Bender Complete Set  
 \$1,516.87/set

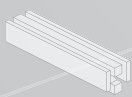
Set Includes housing, KS bending wheel, KS bending strips, and KS small and large guide wedges. Mounting hardware is not included.

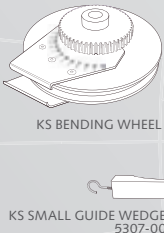

KS, DS BENDING	COMPONENT	PRICE	KS, DS BENDING	COMPONENT	PRICE
• 	Bending Strips <b>5302-00</b> KS	\$26.33 ea.	• 	Small Guide Wedge <b>5307-00</b> KS (pictured)	\$121.33 ea.
	<b>5312-00</b> DS	\$107.72 ea.		<b>5308-00</b> DS white	\$123.35 ea.
• 	Bending Wheel Sets Includes wheel, wedges, and bending strips. <b>55401-00</b> KS	\$878.96/set	• 	<b>5309-00</b> DS grey	\$123.35 ea.
	<b>55402-00</b> DS	\$1,935.72/set		Both DS wedges are required.	
				Large Guide Wedge <b>55102-00</b> KS (pictured)	\$194.12 ea.
			<b>55103-00</b> DS white	\$166.58 ea.	
			<b>55104-00</b> DS grey	\$166.58 ea.	
			Both DS wedges are required.		

BENDING AND CURVING

# BENDING & CURVING



CS | CL | CM | CCS | RTS | KS | DS | DSXL | DSXL LED | RBS | RBS XL | PS | **BENDS & CURVES** | BATONS | WORKROOM & FES

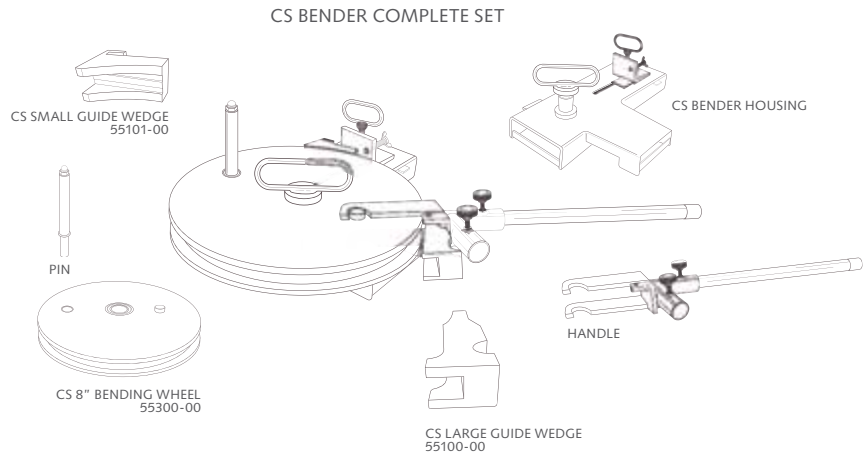

## CS/CCS/FMS/H-RAIL BENDING

**55001-00**  
CS Bender Complete Set  
\$6,277.94/set

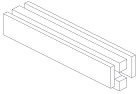
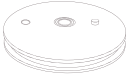

Set includes CS bender housing, CS 8" bending wheel with pin, CS bending strips, CS small and large guide wedges. Mounting hardware is not included.

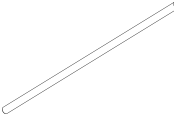

CS, CCS, FMS, H-RAIL BENDING	COMPONENT	PRICE
• 	Bending Strips 55302-00 CS 55303-00 CCS 55306-00 FMS 55314-00 H-Rail	\$129.41 ea. \$129.42 ea. \$58.92 ea. \$164.30 ea.
• 	Bending Wheels 55301-00 CS 6" 55300-00 CS 8" 55310-00 H-Rail	\$740.56 ea. \$2,514.04 ea. \$2,514.06 ea.
• 	Small Guide Wedge 55101-00 CS/CCS/FMS (pictured) 55315-00 H-Rail	\$218.92 ea. \$1,119.30 ea.

CS, CCS, FMS, H-RAIL BENDING	COMPONENT	PRICE
• 	Large Guide Wedge 55100-00 CS/CCS/FMS (pictured) 55316-00 H-Rail	\$218.92 ea. \$1,119.30 ea.
• 	Extension Arm for handle 55317-00	\$115.89 ea.
• 	Stand for CS Bender 55318-00	\$1,054.81 ea.

## KS/CS/CCS/FMS/H-RAIL CURVING











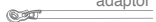

























CURVING	COMPONENT	PRICE
• 	Electronic Continuous Curver 110 Volt curver for accurate and high output curving. Wheels not included. 5004-00	\$19,484.91 ea.
• 	Curving Wheels, set of 3 5304-00 KS 5306-00 DS 5305-00 CS/CCS/FMS 55311-00 H-Rail	\$1,812.45/set \$1,375.03/set \$1,896.09/set \$1,170.21/set

CURVING	COMPONENT	PRICE
• 	Curving Strips 55308-00 KS, 23' 55304-00 DS/CCS, 23' 55307-00 CS/FMS, 23' 55313-00 H-Rail, 23'	\$126.96 ea. \$129.42 ea. \$225.40 ea. \$114.67 ea.

# BATONS



CS | CL | CM | CCS | RTS | KS | DS | DSXL | DSXL LED | RBS | RBS XL | PS | BENDS & CURVES | **BATONS** | WORKROOM & FES

BATONS









BATONS	COMPONENT	PRICE	BATONS	COMPONENT	PRICE
●	 <b>3/8" Fiberglass Baton</b> Must order screw separately  		●	 <b>1/2" Clear Acrylic Baton</b> Must order screw separately  	
	<b>36"</b>			<b>36"</b>	
	54110-25 white w/ snap	\$7.34 ea. 		54510-00 w/ snap	\$10.51 ea. 
	54310-25 white w/ adaptor	\$6.12 ea./box 100		54710-00 w/ adaptor	\$8.75 ea./box 100
	<b>54110-24, -59, -81, -90</b>			<b>48"</b>	
	w/ snap	\$12.84 ea.  \$10.70 ea./box 100		54511-00 w/ snap	\$20.55 ea. 
	<b>48"</b>			54711-00 w/ adaptor	\$17.13 ea./box 100
	54111-25 white w/ snap	\$9.76 ea. 		<b>60"</b>	
	54311-25 white w/ adaptor	\$8.13 ea./box 100		54512-00 w/ snap	\$23.04 ea. 
	<b>54111-24, -59, -65, -81, -90</b>			54712-00 w/ adaptor	\$19.20 ea./box 100
	w/ snap	\$15.30 ea.  \$12.75 ea./box 100		<b>72"</b>	
	<b>60"</b>			54513-00 w/ snap	\$30.74 ea. 
	54112-25 white w/ snap	\$15.34 ea. 		54713-00 w/ adaptor	\$25.62 ea./box 100
	54312-25 white w/ adaptor	\$12.77 ea./box 100			
	<b>54112-24, -59, -81, -90</b>				
w/ snap	\$20.06 ea.  \$16.71 ea./box 100	●	 <b>1/2" Clear Acrylic Baton</b> <b>Fluted</b>  		
<b>72"</b>		<b>36"</b>			
54113-25 white w/ snap	\$17.73 ea. 	54610-00 w/ snap	\$10.51 ea. 		
54313-25 white w/ adaptor	\$14.77 ea./box 100	54810-00 w/ adaptor	\$8.75 ea./box 100		
<b>54113-24, -59, -81, -90</b>		<b>48"</b>			
w/ snap	\$23.28 ea.  \$19.41 ea./box 100	54611-00 w/ snap	\$20.55 ea. 		
<b>84"</b>		54811-00 w/ adaptor	\$17.13 ea./box 100		
54114-25 white w/ snap	\$37.10 ea. 	<b>60"</b>			
54314-25 white w/ adaptor	\$30.91 ea./box 100	54612-00 w/ snap	\$23.04 ea. 		
<b>96"</b>		54812-00 w/ adaptor	\$19.20 ea./box 100		
54115-25 white w/ snap	\$37.10 ea. 	<b>72"</b>			
54315-25 white w/ adaptor	\$30.91 ea./box 100	54613-00 w/ snap	\$30.74 ea. 		
		54813-00 w/ adaptor	\$25.62 ea./box 100		
●	<b>Colors available for 3/8" Fiberglass Batons</b>		●	 <b>9013-00</b> Baton Holder, clear acrylic \$1.95 ea. 1,000/pkg	
	 24 Satin Brass  25 White  59 Black  65 Brown  81 Bronze  90 Silver <small>48" only</small>		●	 <b>54001-16</b> Baton Snap \$0.32 ea. 1,000/pkg	
●	 <b>ADA Clear Acrylic Baton</b>  <b>48"</b> 54911-00 w/ adaptor \$54.66 ea.  \$45.56 ea./box 20  <b>60"</b> 54912-00 w/ adaptor \$63.30 ea.  \$52.75 ea./box 20		●	 <b>9015-00</b> Hex Head Shoulder Screw for baton w/ adaptor \$0.45 ea. 200/bag	
			●	 <b>54000-16</b> D-Ring \$0.63 ea. 1,000/pkg	

 BREAK PACK PRICING  - Prices with this designation indicate a 20% up charge for broken pack quantities.

## DECORATIVE METAL & WOOD BATONS

 <p><b>29MWAND-XX</b> 40" Metal Baton see all finishes p. 33 \$80.45 ea.</p>	 <p><b>29AWAND-16</b> 40" Round Metal Baton Stainless Steel \$84.62 ea.</p>	 <p><b>29SWAND-16</b> 40" Square Metal Baton Stainless Steel \$89.09 ea.</p>	 <p><b>29IWAND-XX</b> 40" Wrought Iron Baton see all finishes p. 39 \$71.54 ea.</p>	 <p><b>19WWAND-XX</b> 40" Wood Baton see all finishes p. 63 \$18.94 ea. unfinished \$23.31 ea. finished \$43.41 ea. antiqued</p>	 <p><b>19CWAND-XX</b> 40" Modern Baton see all finishes p. 63 \$18.94 ea. unfinished \$23.31 ea. finished \$43.41 ea. antiqued</p>
-----------------------------------------------------------------------------------------------------------------------------------------------------------------------------	----------------------------------------------------------------------------------------------------------------------------------------------------------------------------	-----------------------------------------------------------------------------------------------------------------------------------------------------------------------------	------------------------------------------------------------------------------------------------------------------------------------------------------------------------------------	-------------------------------------------------------------------------------------------------------------------------------------------------------------------------------------------------------------------------------------------	---------------------------------------------------------------------------------------------------------------------------------------------------------------------------------------------------------------------------------------------

## WORKROOM COMPONENTS











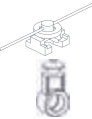

WORKROOM	COMPONENT	PRICE	WORKROOM	COMPONENT	PRICE
●	 <b>9009-00</b> Large Stiffener w/ grommet Adjustable for ceiling or wall	\$1.12 ea.  \$0.93 ea./bag 500	●	 <b>9100-00</b> Channel Protector For CS Track	\$14.06 ea.
●	 <b>9011-00</b> Small Stiffener w/ grommet For sheers	\$0.95 ea.  \$0.79 ea./bag 1000	●	 <b>52500-00</b> Corded Assembly Tool	\$87.89 ea.
●	 <b>9003-25</b> 00 Clear, 59 Black + 10% 1" Snap Tape for Ripplefold 4 1/4" OC spacing	\$5.56/yd.  \$4.63/roll of 100 yds.	●	 <b>5000-00</b> Track Opener	\$50.72 ea.

 BREAK PACK PRICING  - Prices with this designation indicate a 20% up charge for broken pack quantities.

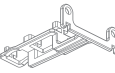

## FES® FOREST EASYFLEX SYSTEM

- Fold depth is fully customizable with Easyflex tape and carriers.
- Ceiling space required is equal to the spacing between the hook placement in the Easyflex tape.
- Fits all Forest Tracks.

FES	COMPONENT	PRICE	FES	COMPONENT	PRICE
●	 <b>2107-25</b> 60%, 2 5/8" OC <b>2106-25</b> 80%, 2 3/8" OC <b>2105-25</b> 100%, 2 1/8" OC <b>2108-25</b> 120%, 1 7/8" OC	\$1.46 ea.  \$1.20 ea./box 500	●	 <b>9037-25</b> Easyflex Hook	\$0.52 ea.  \$0.44 ea./box 500
●	 <b>2114-25</b> 60%, 2 5/8" OC <b>2111-25</b> 80%, 2 3/8" OC <b>2112-25</b> 100%, 2 1/8" OC <b>2115-25</b> 120%, 1 7/8" OC	\$1.17 ea.  \$0.97 ea./box 500	●	 <b>9039-25</b> Easyflex End Hook	\$0.27 ea.  \$0.22 ea./box 1000
			●	 <b>9036-00</b> Easyflex Tape 3" wide, 9/16" spacing	\$4.16/yd.  \$416.00/roll 100 yds
			●	 <b>9040-25</b> Overlap R/L FES Master	\$4.94 ea.  \$4.11 ea./box 25

 BREAK PACK PRICING  - Prices with this designation indicate a 20% up charge for broken pack quantities.



## FOREST DECORATIVE METAL COLLECTIONS

Ringed pole sets, baton draw traversing, cord draw traversing and motorized (see pages 83-90)

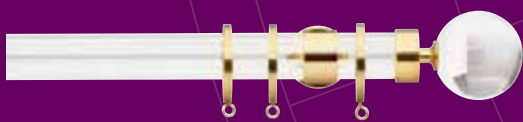

### Glasgow

1 3/8" Acrylic Pole Sets



### Dresden

1 1/8" Brass Pole Sets



### Deventer

1 1/8" Deco Pole Sets



### Lisbon

1 3/16" Brass Pole Sets



### Aveiro

1 3/16" Steel Pole Sets



### Porto

3/4" & 1 3/16" Wrought Iron Pole Sets



Our decorative metal collections offer the perfect combination of style and functionality. With a wide variety of styles from contemporary to traditional, and many stunning finishes, you are sure to find the right hardware for your design.

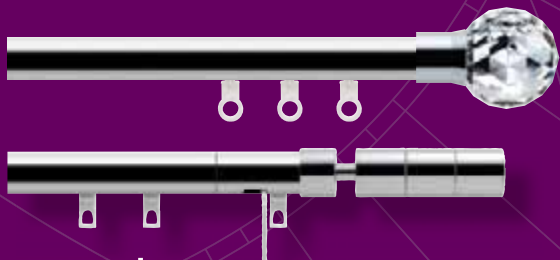

## Dresden

- 1 1/8" Baton Draw Traversing Sets
- 1 1/8" & 1 9/16" Cord Draw Traversing Sets



**MOTOR CONTROL**  
P. 83-88



## Frankfurt

1" Square Rail Traversing Sets



## Stuttgart

Rectangle, C & Oval Rail Traversing



## Deventer CRS

1 1/8" Baton Draw Traversing Sets



**MOTOR CONTROL**  
P. 89-90

# METAL

GLASGOW | DRESDEN | DEVENTER DECO | LISBON | AVEIRO | PORTO | DRESDEN | DEVENTER CRS | FRANKFURT | STUTTGART

METAL POLE SETS GLASGOW ACRYLIC



## GLASGOW COLLECTION

1 3/8" Acrylic Pole Sets  
Recommended weight is 4 lbs/ft. depending on application.



Scan for more information on  
FOREST GLASGOW POLE SETS

AVAILABLE FINISHES XX = finish color

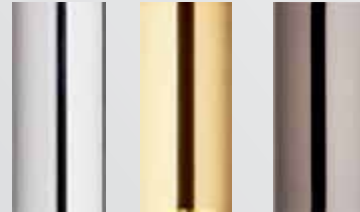

22  
Polished  
Chrome

23  
Polished  
Brass

89  
Graphite



**3335AHP-00**  
1 3/8" Hollow Acrylic Pole, 10'  
\$34.60/ft.



**3035RWB-XX**  
Recess Wall Bracket  
\$65.32 ea.

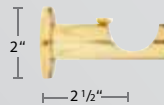

**3035CYL-XX**  
Cylinder Bracket  
\$81.86 ea.

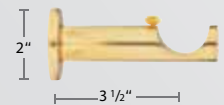

**3035CYE-XX**  
Extended Cylinder Bracket  
\$98.23 ea.

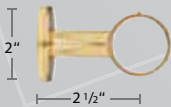

**3035CCB-XX**  
Closed Bracket  
\$98.23 ea.



**3035CWB-XX**  
Extended Closed Bracket  
\$107.15 ea.



**3035RIN-XX**  
Metal Ring w/ Eyelet  
& Plastic Insert  
\$10.28 ea.

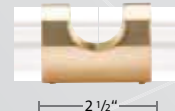

**3035CON-XX**  
Joining Bracket  
\$55.00 ea.



**GLASGOW COLLECTION (CONTINUED)**

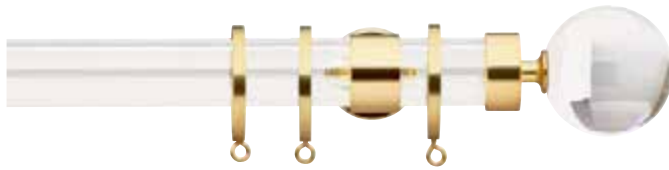

Clear Acrylic Glasgow Pole with Sphere Finial and Polished Brass Collar



Clear Acrylic Glasgow Pole, Pillbox Finial with Polished Chrome Collar, Rings & Bracket



Clear Acrylic Glasgow Pole, Cylinder Finial with Graphite Collar

**GLASGOW COLLECTION FINIALS**

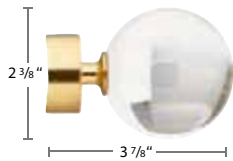

**3035BAL-XX**  
Sphere Finial  
\$137.66 ea.

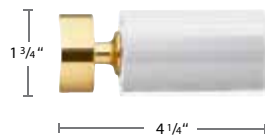

**3035CIL-XX**  
Cylinder Finial  
\$126.51 ea.

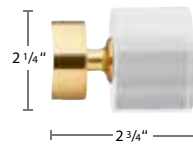

**3035PIL-XX**  
Pillbox Finial  
\$107.90 ea.

# METAL

GLASGOW | DRESDEN | DEVENTER DECO | LISBON | AVEIRO | PORTO | DRESDEN | DEVENTER CRS | FRANKFURT | STUTTGART

METAL POLE SETS DRESDEN



## DRESDEN COLLECTION

1 1/8" Brass Pole Sets with Finials or a French Return  
Recommended weight is 4 lbs/ft. depending on application.



Scan for more information on  
FOREST DRESDEN POLE SETS

### AVAILABLE FINISHES XX = finish color



**B801-28-XX**  
1 1/8" Brass Pole, 16' 4"  
\$26.71/ft.

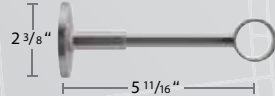

**B11950-28-XX**  
Single Wall or Ceiling Bracket  
\$208.64 ea.

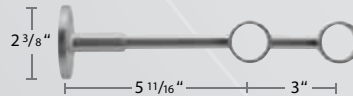

**B11952-28-XX**  
Double Wall Bracket  
\$288.88 ea.



**B11598-28-L-XX**  
**B11598-28-R-XX**  
French Return, 3 1/8" P  
\$163.73 ea.

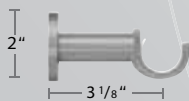

**B400-80-XX**  
Support Bracket for French Return  
\$160.40 ea.



**B122028-XX**  
Inside Mount Bracket  
\$89.86 ea.



**B125930-XX**  
Flat Ring w/ Eyelet  
Includes Plastic Insert  
\$11.28 ea.

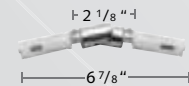

**B122928-XX**  
Swivel Elbow  
\$170.85 ea.



**2030SPL-23**  
Splice  
\$13.55 ea.

**METAL**

GLASGOW | **DRESDEN** | DEVENTER DECO | LISBON | AVEIRO | PORTO | DRESDEN | DEVENTER CRS | FRANKFURT | STUTTART

**DRESDEN COLLECTION (CONTINUED)**



29 Satin Nickel Dresden Pole with French Return



22 Polished Chrome Dresden Pole with Ardea Finial and Socket



24 Satin Brass Dresden Pole with Napoli Finial



59 Black Dresden Double Pole Set with Largo Finial in front and End Cap in back

**DRESDEN COLLECTION FINIALS**

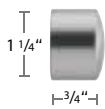

**B124028-XX**  
End Cap Finial  
\$44.94 ea.

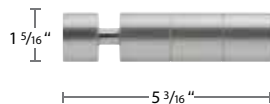

**B690-XX**  
Pescara Finial  
\$253.58 ea.

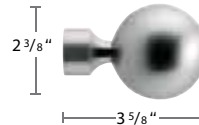

**B3362-XX**  
Alassio Finial  
\$256.77 ea.

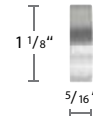

**B124128-XX**  
Alea Finial  
\$63.77 ea.

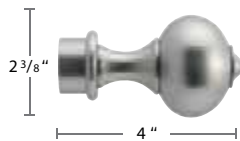

**B650-XX**  
Verona Finial  
\$347.88 ea.



**B610-XX**  
Napoli Finial  
\$318.90 ea.



**B660-22, 24, 29, 70**  
Roma Finial  
\$449.91 ea.

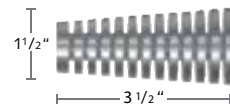

**B3521-28-XX**  
Ischia Finial  
\$220.36 ea.

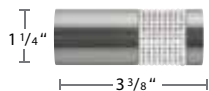

**B315-28-XX**  
Largo Finial  
\$361.06 ea.

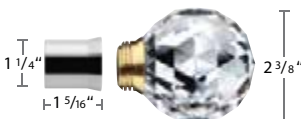

**B3389-100**  
Ardea Finial \$428.93 ea.  
**B3389/1-XX**  
Socket for Ardea Finial \$86.25 ea.

# METAL

GLASGOW | DRESDEN | **DEVENTER DECO** | LISBON | AVEIRO | PORTO | DRESDEN | DEVENTER CRS | FRANKFURT | STUTTART

METAL POLES SETS DEVENTER DECO



## DEVENTER DECO COLLECTION

1 1/8" Aluminum Pole Sets with plastic inlay on pole and inside rings  
Recommended weight is 4 lbs/ft. depending on application.



Scan for more information on  
FOREST DEVENTER DECO POLE SETS

AVAILABLE FINISHES XX = finish color



29  
Satin  
Nickel

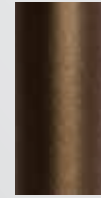

81  
Antique  
Bronze



89  
Graphite



95  
Taupe



**51819-XX**  
1 1/8" Aluminum Pole, 19"  
\$13.41/ft.

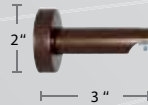

**53401-XX**  
Single Bracket  
3" P  
\$55.57 ea. 2/box

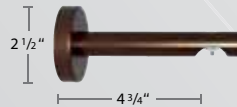

**53402-XX**  
Extended Single Bracket  
4 3/4" P  
\$73.17 ea. 2/box



**53406-XX**  
Double Bracket  
6" P  
Do not use with Ripplefold  
\$105.01 ea. 2/box



**53407-XX**  
Extended Double Bracket  
7 3/4" P  
Use with Ripplefold  
\$117.61 ea. 2/box

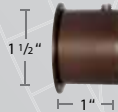

**53412-XX**  
Inside Mount Bracket  
\$87.89 ea. 2/box



**51800-XX**  
Flat Ring  
with plastic insert  
\$22.38 ea. 25/BOX

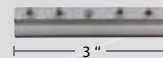

**53413-90**  
Deventer Rail Connector  
aluminum, 3"  
\$18.85 ea. 25/box

**DEVENTER COLLECTION (CONTINUED)**

Ultra quiet and smooth operation with a plastic inlay on the top of the pole and inside the rings.



29 Satin Nickel Deventer Deco Pole with Notched Finial



89 Graphite Deventer Deco Pole with Notched Finial



95 Taupe Deventer Deco Pole with Notched Finial

**DEVENTER COLLECTION FINIALS**

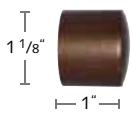

**52430-XX**  
Deventer End Cap Finial  
\$38.46 ea. 10/box



**52431-XX**  
Deventer Ball Finial  
\$80.61 ea. 10/box

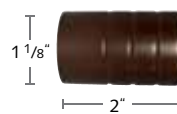

**52432-XX**  
Deventer Notched Finial  
\$44.40 ea. 10/box

# METAL

GLASGOW | DRESDEN | DEVENTER DECO | LISBON | AVEIRO | PORTO | DRESDEN | DEVENTER CRS | FRANKFURT | STUTTGART

METAL POLE SETS LISBON



## LISBON COLLECTION

1 3/16" Brass Pole Sets with Finials or a French Return  
Recommended weight is 4 lbs./ft. depending on application.



Scan for more information on  
FOREST LISBON POLE SETS

### AVAILABLE FINISHES XX = finish color



22 Polished Chrome



23 Polished Brass



24 Satin Brass



27 Rose Gold



29 Satin Nickel

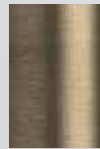

32 Antique Bronze



36 Oil Rubbed Bronze

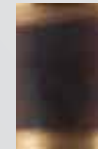

66 French Bronze



89 Graphite



**2030SMP-XX**  
1 3/16" Brass Pole, 16'  
\$36.71/ft.



**2230FRE-XX**  
French Return  
Wall Bracket, 3 1/2"P  
\$67.78 ea.



**2230TOL-XX**  
Toledo Open  
Wall Bracket  
\$55.55 ea.



**2230CIR-XX**  
Irati Closed  
Ceiling Bracket  
\$57.60 ea.

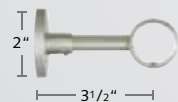

**2230IRA-XX**  
Irati Closed  
Wall Bracket  
\$66.00 ea.

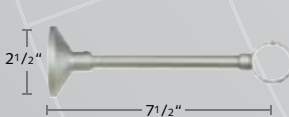

**2230EVI-XX**  
Viana Extended Closed  
Wall Bracket  
\$60.74 ea.



**2230DIR-XX**  
Double Irati  
Wall Bracket  
Not for use w/ grommets  
\$71.99 ea.



**2230OIM-XX**  
Open Inside Mount  
Wall Bracket  
\$31.48 ea.

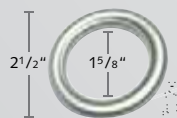

**2330SHR-XX**  
Plastic Lined  
Smooth Hollow Ring  
w/ Clip-on Eyelet  
\$5.45 ea.



**2330FRI-XX**  
Flat Ring  
\$10.29 ea.

**METAL**

GLASGOW | DRESDEN | DEVENTER DECO | LISBON | AVEIRO | PORTO | DRESDEN | DEVENTER CRS | FRANKFURT | STUTTART

**LISBON COLLECTION (CONTINUED)**

22 Polished Chrome Lisbon Pole with French Return



24 Satin Brass Lisbon Pole with French Return



27 Rose Gold Lisbon Pole with Velate Finial



66 French Bronze Lisbon Pole with Toscana Finial



29 Satin Nickel Lisbon Pole with Velate Finial



**LISBON COLLECTION FINIALS, BATON, SPLICE & HOLDBACK**

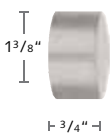

**2130END-XX**  
End Cap Finial  
\$22.01 ea.

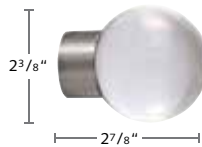

**2130ACR-XX**  
Acrylic Ball Finial  
\$69.58 ea.

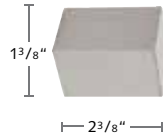

**2130BLO-XX**  
Block Finial  
\$55.21 ea.

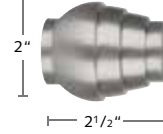

**2130TIE-XX**  
Tier Finial  
\$58.33 ea.

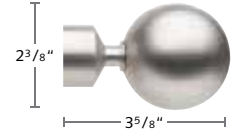

**2130VEL-XX**  
Velate Finial  
\$65.02 ea.

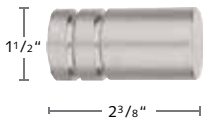

**2130CIL-XX**  
Cilindro Finial  
\$61.53 ea.

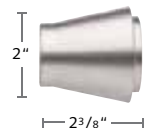

**2130INC-XX**  
Inca Finial  
\$61.81 ea.



**2130SLA-XX**  
Slant Finial  
\$44.67 ea.

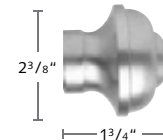

**2130TOS-XX**  
Toscana Finial  
\$46.07 ea.



**29MWAND-XX**  
Metal Control Baton 40"  
\$80.45 ea.  
See all batons p. 23



**2030SPL-23**  
Pole Splice  
\$13.55 ea.

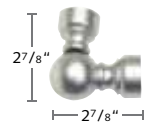

**2130SWI-XX**  
Swivel Corner Connector  
\$73.36 ea.

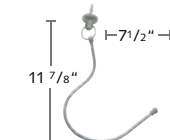

**26SWING-XX**  
Swing Holdback  
\$77.43 ea.

# METAL

GLASGOW | DRESDEN | DEVENTER DECO | LISBON | AVEIRO | PORTO | DRESDEN | DEVENTER CRS | FRANKFURT | STUTTGART

METAL POLE SETS AVEIRO STAINLESS STEEL



## AVEIRO COLLECTION

1 3/16" Stainless Steel Pole Sets with Finials or a French Return  
Recommended weight is 4 lbs/ft. depending on application.



Scan for more information on  
FOREST AVEIRO POLE SETS

### AVAILABLE FINISHES XX = finish color



16  
Stainless Steel  
19'



25  
Shiny White  
19'



59  
Matte Black  
16'

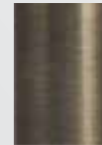

87  
Bronze Brilliant  
16'

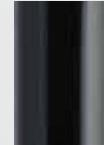

88  
Shiny Black  
19'



**2030SMP-XX**  
1 3/16" Brass Pole  
\$36.71/ft.



**2230FRE-XX**  
French Return  
Wall Bracket, 3 1/2"P  
\$67.78 ea.



**2230CYL-XX**  
Cylinder Wall Bracket  
\$90.23 ea.

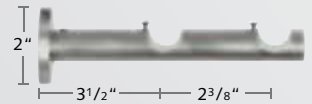

**2230DCB-XX**  
Cylinder Double Wall Bracket  
Not for use w/ grommets  
\$147.52 ea.



**2230CYC-XX**  
Cylinder Ceiling Bracket  
\$100.09 ea.



**2230CIR-XX**  
Irati Closed Ceiling Bracket  
\$57.60 ea.

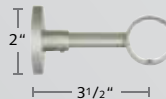

**2230IRA-XX**  
Irati Closed Wall Bracket  
\$66.00 ea.

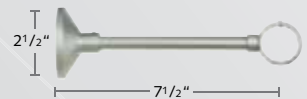

**2230EVI-XX**  
Viana Extended Closed  
Wall Bracket  
\$60.74 ea.

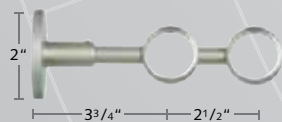

**2230DIR-XX**  
Double Irati Wall Bracket  
Not for use w/ grommets  
\$71.99 ea.



**2230OIM-XX**  
Open Inside Mount  
Bracket  
\$31.48 ea.



**2230FRI-XX**  
Flat Ring  
w/ Plastic Insert  
\$10.29 ea.



**AVEIRO COLLECTION (CONTINUED)**

16 Stainless Steel Aveiro Pole with 87 Bronze Brilliant Components

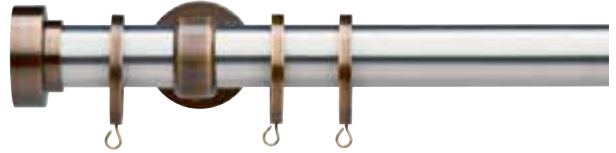

87 Bronze Brilliant Aveiro Pole with French Return

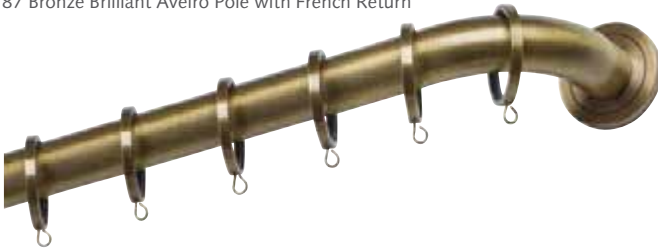

16 Stainless Steel Aveiro Pole with Acrylic Ball Finial



59 Black Matte Aveiro Pole, End Cap and Rings



**LISBON COLLECTION FINIALS, BATON, SPLICE & HOLDBACK**

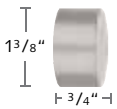

**2130END-XX**  
End Cap Finial  
\$22.01 ea.

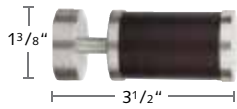

**2130CLM-16** Round Brn  
**2130CLB-16** Round Blk  
only in -16 Stainless Steel  
\$94.81 ea.

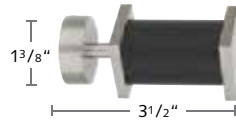

**2130CUM-16** Square Brn  
**2130CUB-16** Square Blk  
only in -16 Stainless Steel  
\$94.51 ea.

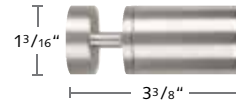

**2130ROL-XX**  
Steel Rollinbild Finial  
\$71.65 ea.

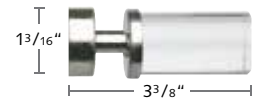

**2130ROL-00** Stainless  
Steel Rollinbild Finial  
**2130ROL-25c, 87c, 88c**  
Clear Rollinbild Finial  
\$83.22 ea.

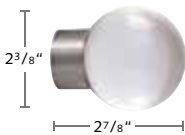

**2130ACR-XX**  
Acrylic Ball Finial  
\$69.58 ea.

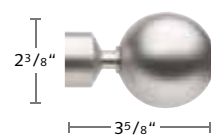

**2130VEL-XX**  
Velate Finial  
\$65.02 ea.

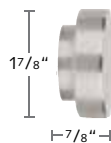

**2130POP-XX**  
Pop Finial  
\$53.31 ea.

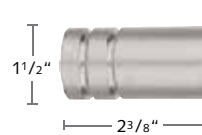

**2130CIL-XX**  
Cilindro Finial  
\$61.53 ea.

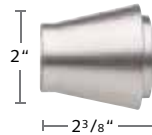

**2130INC-XX**  
Inca Finial  
\$61.81 ea.



**29AWAND-16**  
Round Baton 40"  
\$84.62 ea.  
See all batons p. 23

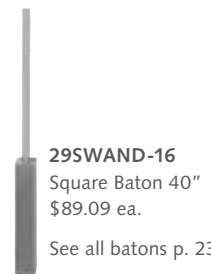

**29SWAND-16**  
Square Baton 40"  
\$89.09 ea.  
See all batons p. 23



**2030SPL-23**  
Pole Splice  
\$13.55 ea.

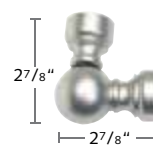

**2130SWI-XX**  
Swivel Corner  
Connector  
\$73.36 ea.

# METAL

GLASGOW | DRESDEN | DEVENTER DECO | LISBON | AVEIRO | **PORTO** | DRESDEN | DEVENTER CRS | FRANKFURT | STUTTART

METAL POLE SETS 3/4" PORTO WROUGHT IRON



## PORTO 3/4" COLLECTION

AVAILABLE FINISHES XX = finish color

3/4" Wrought Iron Pole Sets  
Recommended weight is 4 lbs./ft. depending on application.



Scan for more information on  
FOREST PORTO POLE SETS



33 Black Silver    35 Grey Copper    37 Sand Gold    38 Rust    40 Graphite Rust    59 Black



**2202SIR-XX**  
3/4" Wrought Iron Pole, 13'  
\$7.53/ft.



**2220CEI-XX**  
3/4" Ceiling Bracket  
\$26.34 ea.

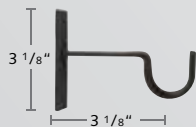

**2220YOR-XX**  
3/4" York Single Open Bracket  
\$27.69 ea.

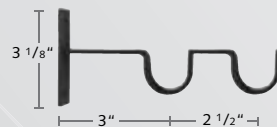

**2220DYO-XX**  
3/4" York Double Open Bracket  
\$36.79 ea.

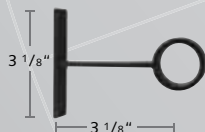

**2220CYR-XX**  
3/4" York Wall/Ceiling Closed Bracket  
\$30.47 ea.

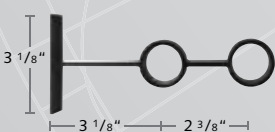

**2220DCY-XX**  
3/4" York Double Wall Closed Bracket  
\$40.59 ea.



**2220ILA-XX**  
3/4" Inside Mount Bracket  
\$15.99 ea.

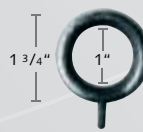

**2320IRI-XX**  
3/4" Smooth Ring w/ Plastic Insert  
\$4.33 ea.

**PORTO 3/4" COLLECTION (CONTINUED)**

37 Sand Gold Porto Pole with Caracola Finial



35 Grey Copper Porto Pole with Bola Finial



38 Rust Porto Pole with Berry Finial



40 Graphite Rust Porto Pole with Troia Finial



**3/4" PORTO COLLECTION FINIALS, BATON & SPLICE**



**2120IEN-XX**  
3/4" End Cap Finial  
\$11.35 ea.

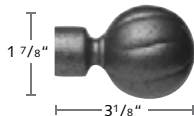

**2120BOL-XX**  
3/4" Bola Finial  
\$32.62 ea.

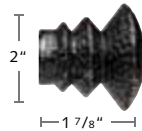

**2120EVE-XX**  
3/4" Everest Finial  
\$30.65 ea.

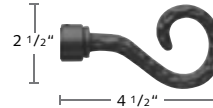

**2120BER-XX**  
3/4" Berry Finial  
\$20.61 ea.

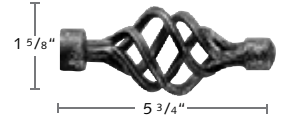

**2120CAR-XX**  
3/4" Caracola Finial  
\$32.61 ea.

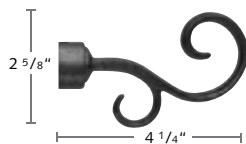

**2120TRO-XX**  
3/4" Troia Finial  
\$22.79 ea.



**2120MAR-XX**  
3/4" Marte Finial  
\$20.61 ea.



**29IWAND-XX**  
Iron Baton 40"  
\$71.54 ea.  
See all batons p. 23



**2020SPL-23**  
Pole Splice  
\$13.55 ea.



**2120SWI-XX**  
3/4" Swivel Corner Connector  
\$56.89 ea.

# METAL

GLASGOW | DRESDEN | DEVENTER DECO | LISBON | AVEIRO | **PORTO** | DRESDEN | DEVENTER CRS | FRANKFURT | STUTTART

METAL POLE SETS 1 3/16" PORTO WROUGHT IRON



## PORTO 1 3/16" COLLECTION

AVAILABLE FINISHES XX = finish color

1 3/16" Wrought Iron Pole Sets  
Recommended weight is 4 lbs/ft. depending on application.



Scan for more information on  
FOREST PORTO POLE SETS

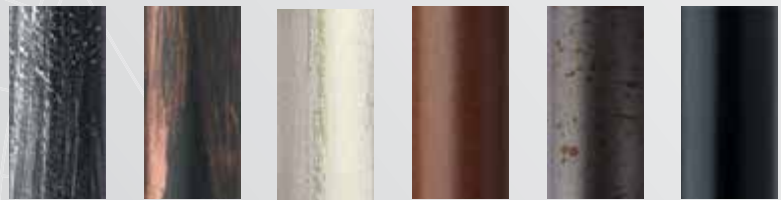

33 Black Silver    35 Grey Copper    37 Sand Gold    38 Rust    40 Graphite Rust    59 Black



**2030SIR-XX**  
1 3/16" Wrought Iron Pole, 13'  
\$10.21/ft.



**2230CEI-XX**  
1 3/16" Ceiling  
Bracket  
\$26.82 ea.

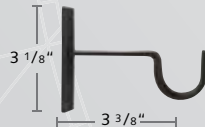

**2230YOR-XX**  
1 3/16" York Single Open  
Bracket  
\$27.69 ea.

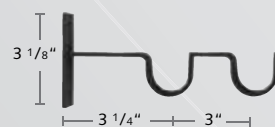

**2230DYO-XX**  
1 3/16" York Double Open  
Bracket  
\$36.90 ea.

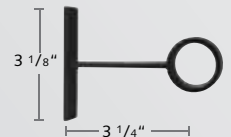

**2230CYR-XX**  
1 3/16" York Single Closed  
Bracket  
\$30.47 ea.

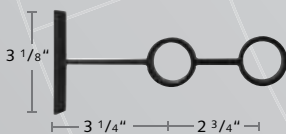

**2230DCY-XX**  
1 3/16" York Double Closed  
Bracket  
\$40.59 ea.



**2230ILA-XX**  
1 3/16" Inside Mount  
Bracket  
\$17.02 ea.



**2230FRT-XX**  
1 3/16" French Return Bracket  
3 3/8" P  
\$34.20 ea.



**2330IRI-XX**  
1 3/16" Smooth Ring  
w/ Plastic Insert  
\$8.58 ea.



**2330FRI-XX**  
1 3/16" Flat Ring  
w/ Plastic Insert  
\$10.29 ea.

**PORTO 1 3/16" COLLECTION (CONTINUED)**

33 Black Silver Porto Pole with French Return Bracket



37 Sand Gold Porto Pole with Troia Finial and York Closed Bracket



35 Grey Copper Porto Pole with York Open Bracket and Caracola Finial



59 Black Porto Pole with Ball Finial and York Closed Bracket

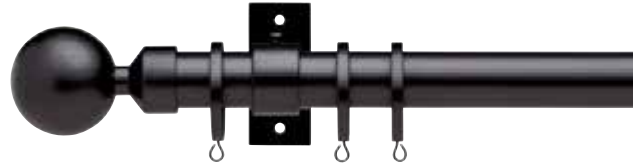

**1 3/16" PORTO COLLECTION FINIALS & BATON**

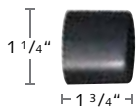

**2130IEN-XX**  
1 3/16" End Cap Finial  
\$12.92 ea.

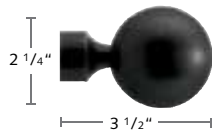

**2130BAL-XX**  
1 3/16" Ball Finial  
\$56.47 ea.

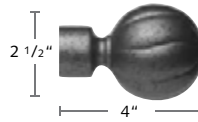

**2130BOL-XX**  
1 3/16" Bola Finial  
\$56.47 ea.

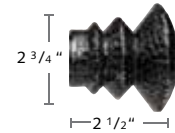

**2130EVE-XX**  
1 3/16" Everest Finial  
\$34.06 ea.

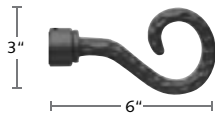

**2130BER-XX**  
1 3/16" Berry Finial  
\$22.89 ea.

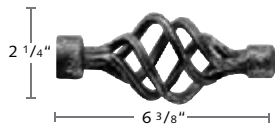

**2130CAR-XX**  
1 3/16" Caracola Finial  
\$58.96 ea.

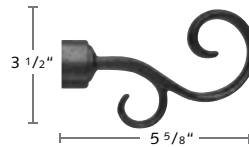

**2130TRO-XX**  
1 3/16" Troia Finial  
\$25.32 ea.



**2130MAR-XX**  
1 3/16" Marte Finial  
\$22.89 ea.

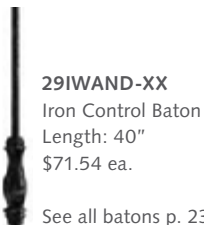

**29IWAND-XX**  
Iron Control Baton  
Length: 40"  
\$71.54 ea.

See all batons p. 23



**2030SPL-23**  
Pole Splice  
\$13.55 ea.



**2130SWI-XX**  
1 3/16" Swivel Corner  
Connector  
\$90.07 ea.

# METAL

GLASGOW | DRESDEN | DEVENTER DECO | LISBON | AVEIRO | PORTO | **DRESDEN** | DEVENTER CRS | FRANKFURT | STUTTGART

METAL TRAVERSING DRESDEN



Scan for more information on FOREST DRESDEN TRAVERSING

## DRESDEN TRAVERSING



**MOTOR CONTROL**  
P. 83-88

- 1 1/8" heavy duty hand or baton draw h-rail system for one- or two-way pinch pleat or ripplefold drapery.
- Wall or ceiling mount. See bracket count below.

Up to 60" = 2 brackets  
61-120" = 3 brackets  
121-180" = 4 brackets  
181-240" = 5 brackets

- Maximum weight is 4 lbs per foot depending on application.
- Bendable – Dresden traversing can be curved and reversed curved using an 8" radius or continuous curve. An exact size template is required. See page 21-22 for more information.
- See corded version on pages 43-44 and motorized version on pages 81-86.

### ASSEMBLED PRICING

Includes rail, end cap finial, carriers, end stop, masters, wall or ceiling brackets, and 36" white fiberglass baton (see all batons p. 23). Indicate pinch pleat or ripplefold when ordering. Freight is additional.

DRESDEN TRAVERSING	first 4 feet	ea. add'l foot
Single	\$693.31	\$105.75
Double	\$1,386.61	\$211.33



70 Bronze Matte Rail with 70 Bronze Matte Roma Finial

22 Polished Chrome Rail with Ardea Finial and Socket

223 Oak Foil Rail with 29 Satin Nickel Alassio Finial









### AVAILABLE FINISHES XX/XXX = finish color

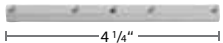
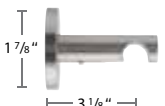
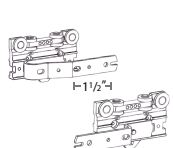
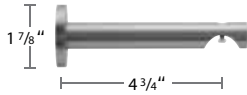
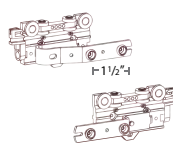
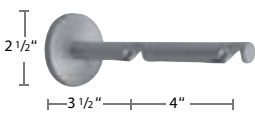
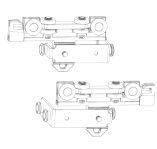

22 Polished Chrome    24 Satin Brass    26 Brushed Gold    29 Satin Nickel    70 Bronze Matte    59 Black    222 Beech    223 Oak    224 Walnut

# METAL

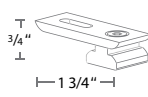
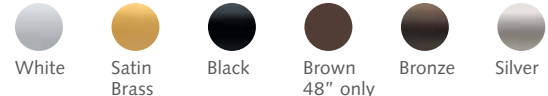
GLASGOW | DRESDEN | DEVENTER DECO | LISBON | AVEIRO | PORTO | **DRESDEN** | DEVENTER CRS | FRANKFURT | STUTTGART

DRESDEN	COMPONENT	PRICE	DRESDEN	COMPONENT	PRICE	
●	 1 1/8" H-Rail	<b>B808-28-XX</b> 1 1/8" Aluminum H-Rail 19' 7"	●	 52002-25 24 gold, 59 black, 65 brown, 90 silver + 10% Slim Line Ball Bearing Carrier	\$27.37/ft. \$32.84/ft. foiled 222, 223, 224	\$0.65 ea. \$0.53 ea. /box of 1,000
●	 4 1/4" Rail Connector	<b>B899-4-00</b> 1 1/8" & 1 9/16" Rail Connector	●	 B8809-23-00 Overlap R B8809-24-00 Underlap L 59 black + 10% Plastic Snap Master	\$38.12 ea.	\$12.26 ea. \$10.21 ea. /box of 25
●	 1 7/8" x 3 1/8" Single Wall Bracket	<b>B11670-XX</b> Single Wall Bracket	●	 52502-25 Overlap R 52504-25 Underlap L 59 black + 10% Standard Multi-Functional Master Use stiffener w/ exposed baton or hooks w/ hidden baton	\$141.23 ea.	\$6.98 ea. \$5.82 ea. /box of 100
●	 1 7/8" x 4 3/4" Extended Single Wall Bracket	<b>B11670-120-XX</b> Extended Single Wall Bracket	●	 52502-25A Overlap R 52504-25A Underlap L 59A black + 10% Standard Multi-Functional Master w/ snaps	\$150.00 ea.	\$8.46 ea. \$7.06 ea. /box of 100
●	 2 1/2" x 3 1/2" x 4" Double Wall Bracket	<b>B11672-190-XX</b> Double Wall Bracket	●	 52411-25A Butt R 52412-25A Butt L 24A gold, 59A black, 65A brown, 90A silver Wheeled Butt Master w/snap adaptor Designed for hidden baton	\$170.12 ea.	\$29.94 ea. \$24.94 ea. /box of 50
●	 1 7/8" x 1 11/16" x 1 5/8" Ceiling Bracket	<b>B11873-50-XX</b> Ceiling Bracket	●	 B122928-XX Swivel Elbow	\$102.71 ea.	\$170.85 ea.
●	 5/8" x 9/16" Ceiling Bracket 5/8" Extension	<b>B11873-15-XX</b> Ceiling Bracket 5/8" Extension	●	 V799-2-00 End Stop	\$54.57 ea.	\$0.85 ea. \$0.70 ea. /box of 100
●	 3/4" x 1 3/4" Flush Ceiling Bracket Cannot use finials	<b>53408-XX</b> 22 chrome, 25 white, 24 gold, 29 satin nickel, 59 black Flush Ceiling Bracket Cannot use finials	●	Fiberglass batons in 36", 48", 60" and 72" lengths and these colors. See all batons page 23.		
●	 1 7/8" x 3" French Return, 3 1/8" P	<b>B11598-28-L-XX</b> <b>B11598-28-R-XX</b> French Return, 3 1/8" P	●	 White Satin Brass Black Brown 48" only Bronze Silver	\$163.73 ea.	
●	 Wheeled Connected Snap Carriers on plastic strip 2207-25 60% fullness, 2 5/8" OC 2206-25 24 gold, 59 black, 65 brown, 90 silver 80% fullness, 2 3/8" OC 2205-25 100% fullness, 2 1/8" OC 2208-25 120% fullness, 1 7/8" OC	\$1.88 ea. \$1.57 ea. /box of 500  Colors other than white, in 80% only, +10%	FINIALS ARE OPTIONAL. SEE PAGE 30 FOR CHOICES.			

**BREAK PACK PRICING** - Prices with this designation indicate a 20% up charge for broken pack quantities.

METAL TRAVERSING DRESDEN

# METAL

GLASGOW | DRESDEN | DEVENTER DECO | LISBON | AVEIRO | PORTO | **DRESDEN** | DEVENTER CRS | FRANKFURT | STUTTGART

METAL TRAVERSING DRESDEN 1 1/8" CORDED



Scan for more information on  
FOREST DRESDEN 1 1/8" CORDED

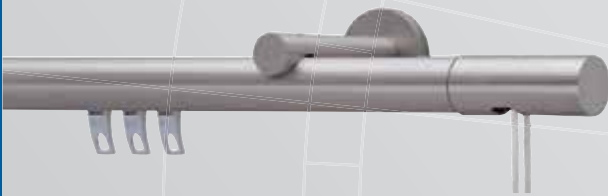

1 1/8" Dresden Corded Traversing System in 29 Satin Nickel



**MOTOR CONTROL**  
P. 83-88

## DRESDEN 1 1/8" CORDED

- Light duty cord draw system for one- or two-way pinch pleat or ripplefold drapery.
- Wall or ceiling mount. See bracket count below.
  - Up to 60" = 2 brackets
  - 61-120" = 3 brackets
  - 121-180" = 4 brackets
  - 181-240" = 5 brackets
- Bendable – 1 1/8" Dresden Corded can be curved and reversed curved using an 8" radius or continuous curve. An exact size template is required. Polished chrome rails cannot be bent or curved. See page 21-22 for more information.
- Maximum weight is 50 lbs. Not designed to pull heavy weight draperies.
- See hand drawn version on pages 41-42 and motorized version on pages 81-86.

### ASSEMBLED PRICING

Includes rail, cord pulley in finished housing (Finials are optional and must be ordered separately. See page 30.), carriers, masters, wall or ceiling brackets and child safety device. Indicate pinch pleat or ripplefold when ordering. Freight is additional.

DRESDEN 1 1/8" CORDED	first 4 feet	ea. add'l foot
1 1/8" Single	\$897.27	\$111.77
1 1/8" Double	\$1,794.54	\$223.54

### AVAILABLE FINISHES

XX = finish color



22  
Polished Chrome



26  
Brushed Gold



29  
Satin Nickel











59  
Black

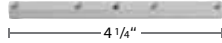
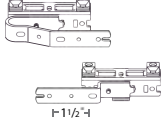
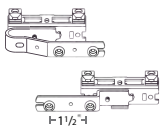

# METAL

GLASGOW | DRESDEN | DEVENTER DECO | LISBON | AVEIRO | PORTO | **DRESDEN** | DEVENTER CRS | FRANKFURT | STUTTGART

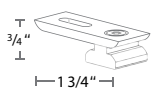
1 1/8" CORDED	COMPONENT	PRICE	1 1/8" CORDED	COMPONENT	PRICE
	<b>B809-28-XX</b> 1 1/8" Aluminum Rail for Cord Draw 19' 7"	\$45.74/ft.		Two Piece Connected Snap Carrier w/ Square Base, in plastic sleeve. Use 1 1/4" snap tape <b>2114-25, 59</b> black 60% fullness, 2 5/8" OC <b>2111-25, 65</b> brown, <b>90</b> silver 80% fullness, 2 3/8" OC <b>2112-25, 59</b> black 100% fullness, 2 1/8" OC <b>2115-25, 59</b> black 120% fullness, 1 7/8" OC	\$1.17 ea. \$0.97 ea. /roll of 500  Colors other than white +10%
	<b>B11687-XX</b> 1 1/8" Cord Pulley in finished housing Finial optional	\$86.68 ea.		<b>52008-25</b> <b>65</b> brown +10% Slim Line Klick Carrier Allows drapery to hang and conceal track	\$1.03 ea. \$0.86 ea. /box of 250
	<b>B11686-XX</b> 1 1/8" Return Pulley in finished housing Finial optional	\$112.67 ea.		<b>52009-25</b> Ball Bearing Carrier	\$1.46/ea. \$1.20/ea. /bundle of 250
	<b>B899-4-00</b> Rail Connector	\$38.12 ea.		<b>52508-25</b> Overlap R <b>52509-25</b> Underlap L <b>59</b> black, <b>65</b> brown, <b>90</b> silver +10% Swivel Foot Multi-Functional Master	\$12.31 ea. \$10.27 ea. /box of 100
	<b>B11670-XX</b> 1 1/8" Single Wall Bracket	\$141.23 ea.		<b>52508-25A</b> Overlap R <b>52509-25A</b> Underlap L <b>59</b> black, <b>65</b> brown, <b>90</b> silver +10% Swivel Foot Multi-Functional Master w/ snaps	\$14.59 ea. \$12.16 ea. /box of 100
	<b>B11672-190-XX</b> 1 1/8" Double Wall Bracket	\$170.12 ea.		<b>52510-25</b> <b>65</b> brown +10% Cord Connector	\$2.27 ea. \$1.89 ea. /box of 100
	<b>B11873-50-XX</b> Ceiling Bracket	\$102.71 ea.		<b>9004-25</b> 3.2mm Cord 273.4 yds./roll	\$1.95/yd. \$1.62/yd. for 273.4 yds
	<b>B11873-15-XX</b> Ceiling Bracket 5/8" Extension	\$54.57 ea.		<b>49501-25</b> Tension Device For child safety	\$8.19 ea. \$6.81 ea. /box 250
	<b>53408-XX</b> <b>22</b> chrome, <b>25</b> white, <b>24</b> gold, <b>29</b> satin nickel, <b>59</b> black Flush Ceiling Bracket Cannot use finials	\$20.28 ea.			

**BREAK PACK PRICING** - Prices with this designation indicate a 20% up charge for broken pack quantities.

FINIALS ARE OPTIONAL. SEE PAGE 30 FOR CHOICES.

METAL TRAVERSING DRESDEN 1 1/8" CORDED

# METAL

GLASGOW | DRESDEN | DEVENTER DECO | LISBON | AVEIRO | PORTO | **DRESDEN** | DEVENTER CRS | FRANKFURT | STUTTART

METAL TRAVERSING DRESDEN 1 9/16" CORDED



Scan for more information on  
FOREST DRESDEN 1 9/16" CORDED

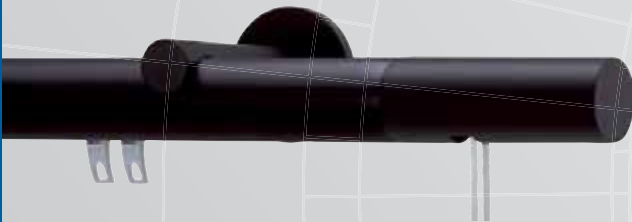

1 9/16" Dresden Corded Traversing System in 59 Black



**MOTOR CONTROL**  
P. 81-86

## DRESDEN 1 9/16" CORDED

- Light duty cord draw system for one- or two-way pinch pleat or ripplefold drapery.
- Wall or ceiling mount. See bracket count below.
  - Up to 60" = 2 brackets
  - 61-120" = 3 brackets
  - 121-180" = 4 brackets
  - 181-240" = 5 brackets
- Maximum weight is 50 lbs. Not designed to pull heavy weight draperies.
- See motorized version on pages 81-86.

### ASSEMBLED PRICING

Includes rail, cord pulley in finished housing, carriers, masters, wall or ceiling brackets and child safety device. Indicate pinch pleat or ripplefold when ordering. Freight is additional.

DRESDEN 1 9/16" CORDED	first 4 feet	ea. add'l foot
1 9/16" Single	\$1,110.82	\$113.60
1 9/16" Double	\$2,221.65	\$227.20

### AVAILABLE FINISHES XX = finish color



29 Satin Nickel



59 Black

# METAL

GLASGOW | DRESDEN | DEVENTER DECO | LISBON | AVEIRO | PORTO | **DRESDEN** | DEVENTER CRS | FRANKFURT | STUTTGART

1 9/16" CORDED	COMPONENT	PRICE	1 9/16" CORDED	COMPONENT	PRICE
	<b>B809-40-XX</b> 1 9/16" Aluminum Rail for Cord Draw 19' 7"	\$50.41/ft.		Two Piece Connected Snap Carrier w/ Square Base, in plastic sleeve. Use 1 1/4" snap tape <b>2114-25, 59</b> black 60% fullness, 2 5/8" OC <b>2111-25, 65</b> brown, <b>90</b> silver 80% fullness, 2 3/8" OC <b>2112-25, 59</b> black 100% fullness, 2 1/8" OC <b>2115-25, 59</b> black 120% fullness, 1 7/8" OC	\$1.17 ea.  \$0.97 ea. /roll of 500  Colors other than white +10%
	<b>B11687-40-XX</b> 1 9/16" Cord Pulley in finished housing	\$143.56 ea.		<b>52008-25</b> <b>65</b> brown +10% Slim Line Klick Carrier Allows drapery to hang and conceal track	\$1.03 ea.  \$0.86 ea. /box of 250
	<b>B11686-40-XX</b> 1 9/16" Return Pulley in finished housing	\$143.56 ea.		<b>52009-25</b> Ball Bearing Carrier	\$1.46/ea.  \$1.20/ea. /bundle of 250
	<b>B899-4-00</b> Rail Connector	\$38.12 ea.		<b>52508-25</b> Overlap R <b>52509-25</b> Underlap L <b>59</b> black, <b>65</b> brown, <b>90</b> silver +10% Swivel Foot Multi-Functional Master	\$12.31 ea.  \$10.27 ea. /box of 100
	<b>B40970-XX</b> 1 9/16" Single Wall Bracket	\$152.06 ea.		<b>52508-25A</b> Overlap R <b>52509-25A</b> Underlap L <b>59A</b> black, <b>65A</b> brown, <b>90A</b> silver +10% Swivel Foot Multi-Functional Master w/ snaps	\$14.59 ea.  \$12.16 ea. /box of 100
	<b>B40872-XX</b> 1 9/16" Double Wall Bracket	\$185.86 ea.		<b>52510-25</b> <b>65</b> brown +10% Cord Connector	\$2.27 ea.  \$1.87 ea. /box of 100
	<b>B11873-50-XX</b> Ceiling Bracket	\$102.71 ea.		<b>9004-25</b> 3.2mm Cord 273.4 yds./roll	\$1.95/yd.  \$1.62/yd. for 273.4 yds
	<b>B11873-15-XX</b> Ceiling Bracket 5/8" Extension	\$54.57 ea.		<b>49501-25</b> Tension Device For child safety	\$8.19 ea.  \$6.81 ea. /box 250
	<b>53408-XX</b> <b>25</b> white, <b>29</b> satin nickel, <b>59</b> black Flush Ceiling Bracket Cannot use finials	\$20.28 ea.			

 **BREAK PACK PRICING**  - Prices with this designation indicate a 20% up charge for broken pack quantities.

# METAL

GLASGOW | DRESDEN | DEVENTER DECO | LISBON | AVEIRO | PORTO | DRESDEN | **DEVENTER CRS** | FRANKFURT | STUTTGART

METAL TRAVERSING DEVENTER CRS



Scan for more information on  
FOREST DEVENTER CRS TRAVERSING



59 Black Deventer CRS Rail with Ball Finial in front & End Cap in back



81 Antique Bronze Deventer CRS Rail with End Cap Finial



29 Satin Nickel Deventer CRS Rail with Notched Finial

## DEVENTER CRS® TRAVERSING

- 1 1/8" heavy duty baton draw h-rail system for one- or two-way pinch pleat or ripplefold drapery.
- Wall or ceiling mount. See bracket count below.
  - Up to 60" = 2 brackets
  - 61-120" = 3 brackets
  - 121-180" = 4 brackets
  - 181-240" = 5 brackets
- Maximum weight is 4 lbs per foot depending on application.
- Bendable – Deventer CRS traversing can be curved and reversed curved using an 8" radius or continuous curve. An exact size template is required. See page 21-22 for more information.
- See motorized version on pages 87-88.

### ASSEMBLED PRICING

Includes rail, end cap finial, carriers, end stop, masters, wall or ceiling brackets and 36" white fiberglass baton (see all batons p. 23). Indicate pinch pleat or ripplefold when ordering. Freight is additional.

DEVENTER CRS TRAVERSING	first 4 feet	ea. add'l foot
Single	\$551.43	\$68.29
Double	\$1,102.86	\$136.57

### AVAILABLE FINISHES XX = finish color



24 Satin Brass



25 White



29 Satin Nickel



59 Black

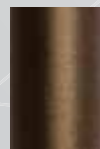

81 Antique Bronze















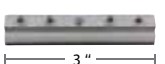





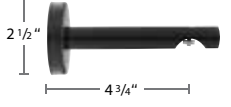
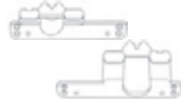

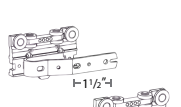
89 Graphite

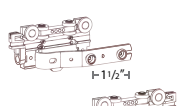

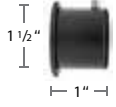
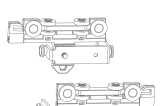

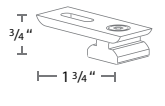
95 Taupe

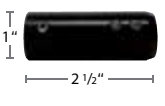
# METAL

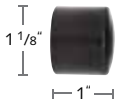
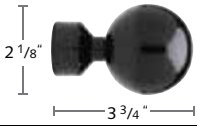
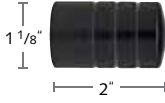
GLASGOW | DRESDEN | DEVENTER DECO | LISBON | AVEIRO | PORTO | DRESDEN | **DEVENTER CRS** | FRANKFURT | STUTTGART

DEVENTER	COMPONENT	PRICE	DEVENTER	COMPONENT	PRICE
●	 <b>51419-XX</b> 1 1/8" Aluminum CRS Rail 19'	\$15.35/ft.	●	 Wheeled Connected Snap Carriers on plastic strip <b>2207-25</b> 60% fullness, 2 5/8" OC <b>2206-25, 24, 59, 65, 90</b> 80% fullness, 2 3/8" OC <b>2205-25</b> 100% fullness, 2 1/8" OC <b>2208-25</b> 120% fullness, 1 7/8" OC	\$1.88 ea.  \$1.57 ea. /box of 500
●	 <b>53413-90</b> Rail Connector aluminum, 3"	\$18.85 ea. 25/box	●	 <b>52002-25</b> 24 gold, 59 black, 65 brown, 90 silver + 10% Slim Line Ball Bearing Carrier	\$0.65 ea.  \$0.53 ea. /box of 1,000
●	 <b>53401-XX</b> Single Wall Bracket 3" P	\$55.57 ea. 2/box	●	 <b>52110-25</b> CRS Carrier UV-proof, synthetic material	\$0.45 ea.  \$0.38 ea. /box of 500
●	 <b>53402-XX</b> Extended Single Wall Bracket 4 3/4" P	\$73.17 ea. 2/box	●	 <b>B8809-23-00</b> Overlap R <b>B8809-24-00</b> Underlap L 59 black + 10% Plastic Snap Master	\$12.26 ea.  \$10.21 ea. /box of 25
●	 <b>53406-XX</b> Double Wall Bracket 6" P Do not use w/ Ripplefold	\$105.01 ea. 2/box	●	 <b>52502-25</b> Overlap R <b>52504-25</b> Underlap L 59 black +10% Standard Multi-Functional Master Use stiffener w/ exposed baton or hooks w/ hidden baton	\$6.98 ea.  \$5.82 ea. /box of 100
●	 <b>53407-XX</b> Extended Double Wall Bracket 7 3/4" P Use w/ Ripplefold	\$117.61 ea. 2/box	●	 <b>52502-25A</b> Overlap R <b>52504-25A</b> Underlap L 59A black +10% Standard Multi-Functional Master w/ snaps	\$8.46 ea.  \$7.06 ea. /box of 100
●	 <b>53412-XX</b> Inside Mount Bracket	\$87.89 ea. 2/box	●	 <b>52411-25A</b> Butt R <b>52412-25A</b> Butt L 24A gold, 59A black, 65A brown, 90A silver Wheeled Butt Master w/snap adaptor Designed for hidden baton	\$29.94 ea.  \$24.94 ea. /box of 50
●	 <b>53408-XX</b> 22 chrome, 25 white, 24 gold, 29 satin nickel, 59 black Flush Ceiling Bracket Cannot use finials	\$20.28 ea.	●	 <b>2551-25</b> Small Extension Arm	\$4.16 ea.  \$3.45 ea. /box of 50
●	 <b>53403-XX</b> Bracket Extension	\$72.22 ea. 10/box	●	 <b>52420-25</b> Metal End Stop w/ Screw To attach carrier as end stop	\$14.06 ea. 100/box
●	 <b>52430-XX</b> End Cap Finial	\$38.46 ea. 10/box			
●	 <b>52431-XX</b> Ball Finial	\$80.61 ea. 10/box			
●	 <b>52432-XX</b> Notched Finial	\$44.40 ea. 10/box			

 **BREAK PACK PRICING**  - Prices with this designation indicate a 20% up charge for broken pack quantities.

METAL TRAVERSING DEVENTER CRS

# METAL

GLASGOW | DRESDEN | DEVENTER DECO | LISBON | AVEIRO | PORTO | DRESDEN | DEVENTER CRS | **FRANKFURT** | STUTTGART

METAL TRAVERSING FRANKFURT



Scan for more information on  
FOREST FRANKFURT SQUARE RAIL



22 Polished Chrome Square Rail, Fina End Cap and Bracket



29 Satin Nickel Square Rail, Fina End Cap and Invisible Bracket



59 Black Square Rail with 22 Polished Chrome Fina End Cap and Bracket

## FRANKFURT SQUARE RAIL

- 1" traversing square rail system for one- or two-way pinch pleat or ripplefold drapery.
- Wall or ceiling mount. See bracket count below.
  - Up to 60" = 2 brackets
  - 61-120" = 3 brackets
  - 121-180" = 4 brackets
  - 181-240" = 5 brackets
- Maximum weight is 4 lbs per foot depending on application.

### ASSEMBLED PRICING

Includes rail, end cap finial, carriers, end stop, masters, wall or ceiling brackets and 36" white fiberglass baton (see all batons p. 23). Indicate pinch pleat or ripplefold when ordering. Freight is additional.

FRANKFURT SQUARE RAIL	first 4 feet	ea. add'l foot
Single	\$779.32	\$155.65
Double	\$1,558.64	\$262.64

### AVAILABLE FINISHES XX = finish color



22 Polished Chrome













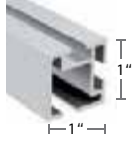
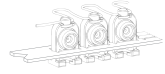

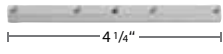





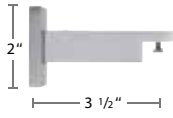
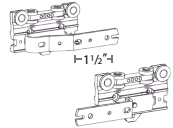

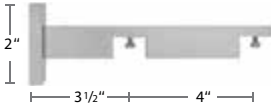
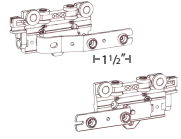

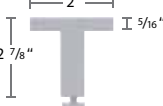

29 Satin Nickel

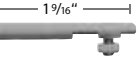

59 Black

# METAL

GLASGOW | DRESDEN | DEVENTER DECO | LISBON | AVEIRO | PORTO | DRESDEN | DEVENTER CRS | **FRANKFURT** | STUTTGART

SQUARE	COMPONENT	PRICE	SQUARE	COMPONENT	PRICE
	<b>B8082525-XX</b> 1" Square Rail 19' 7"	\$50.41/ft.		Wheeled Connected Snap Carriers on plastic strip <b>2207-25</b> 60% fullness, 2 5/8" OC <b>2206-25, 59</b> black, <b>90</b> silver 80% fullness, 2 3/8" OC <b>2205-25</b> 100% fullness, 2 1/8" OC <b>2208-25</b> 120% fullness, 1 7/8" OC	\$1.88 ea.  \$1.57 ea. /box of 500  Colors other than white, in 80% only, +10%
	<b>B899-4-00</b> 1 1/8" & 1 9/16" Rail Connector	\$38.12 ea.		Wheeled Connected Snap Carrier in plastic sleeve <b>2107-25, 59</b> black 60% fullness, 2 5/8" OC <b>2106-25, 59</b> black, <b>90</b> silver 80% fullness, 2 3/8" OC <b>2105-25, 24</b> gold, <b>59</b> black, <b>65</b> brown, <b>90</b> silver 100% fullness, 2 1/8" OC <b>2108-25, 59</b> black 120% fullness, 1 7/8" OC	\$1.46 ea.  \$1.20 ea. /roll of 500  Colors other than white +10%
	<b>B1242525-XX</b> Fina End Cap Finial	\$45.29 ea.		<b>52002-25</b> 24 gold, <b>59</b> black, <b>65</b> brown, <b>90</b> silver + 10% Slim Line Ball Bearing Carrier	\$0.65 ea.  \$0.53 ea. /box of 1000
	<b>B11470-25-XX</b> Wall Bracket	\$185.70 ea.		<b>52502-25</b> Overlap R <b>52504-25</b> Underlap L <b>59</b> black + 10% Standard Multi-Functional Master Use stiffener w/ exposed baton or hooks w/ hidden baton	\$6.98 ea.  \$5.82 ea. /box of 100
	<b>B11472-25-XX</b> Double Wall Bracket	\$246.24 ea.		<b>52502-25A</b> Overlap R <b>52504-25A</b> Underlap L <b>59A</b> black + 10% Standard Multi-Functional Master w/ snaps	\$8.46 ea.  \$7.06 ea. /box of 100
	<b>B11470-40-XX</b> Bracket Extension for B11470-25-XX and B11472-25-XX	\$55.71 ea.		<b>B11473-80-XX</b> Ceiling Bracket/ Invisible Wall Bracket	\$203.63 ea.
	<b>B11473-15-XX</b> Ceiling Bracket 5/8" Extension	\$89.13 ea.		<b>V799-2-00</b> End Stop	\$0.85 ea.  \$0.70 ea. /box of 100
	<b>B11592-00</b> Flush Ceiling Bracket	\$23.33 ea.	Fiberglass batons in 36", 48", 60" and 72" lengths and these colors. See all batons page 23.		
 <b>BREAK PACK PRICING</b>  - Prices with this designation indicate a 20% up charge for broken pack quantities.		 White  Satin Brass  Black  Brown  Bronze  Silver			

METAL TRAVERSING FRANKFURT

# METAL

GLASGOW | DRESDEN | DEVENTER DECO | LISBON | AVEIRO | PORTO | DRESDEN | DEVENTER CRS | FRANKFURT | **STUTTGART**

METAL TRAVERSING STUTTGART RECTANGLE RAIL



Scan for more information on FOREST RECTANGLE RAIL



22 Polished Chrome Rectangle Rail with 29 Satin Nickel Bracket and Square Finial with Spacer



29 Satin Nickel Rectangle Rail with Satin Nickel End Cap Finial and Invisible Bracket

## AVAILABLE FINISHES XX = finish color



22 Polished Chrome



29 Satin Nickel



59 Black

## STUTTGART RECTANGLE RAIL

- Rectangle rail system for one- or two-way pinch pleat or ripplefold drapery.
- Wall or ceiling mount. See bracket count below.
  - Up to 60" = 2 brackets
  - 61-120" = 3 brackets
  - 121-180" = 4 brackets
  - 181-240" = 5 brackets
- Maximum weight is 4 lbs per foot depending on application.

### ASSEMBLED PRICING











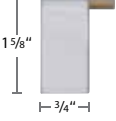
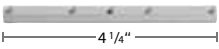
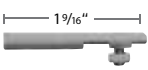
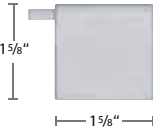
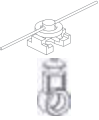

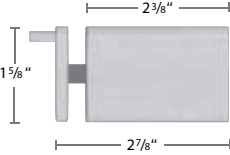
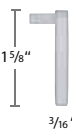
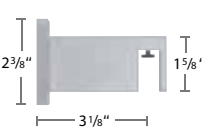
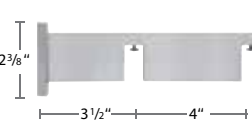

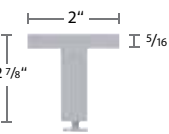
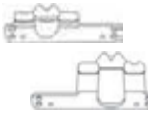

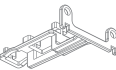
Includes rail, end cap finial, carriers, end stop, masters, wall or ceiling brackets and 36" white fiberglass baton (see all batons p. 23). Indicate pinch pleat or ripplefold when ordering. Freight is additional.

RECTANGLE RAIL	first 4 feet	ea. add'l foot
Single	\$832.10	\$180.66
Double	\$1,664.21	\$361.32



# METAL

GLASGOW | DRESDEN | DEVENTER DECO | LISBON | AVEIRO | PORTO | DRESDEN | DEVENTER CRS | FRANKFURT | **STUTT GART**

RECTANGLE	COMPONENT	PRICE	RECTANGLE	COMPONENT	PRICE
	<b>B8084015-XX</b> Rectangle Rail 19' 7"	\$40.78/ft.		<b>B1224015-XX</b> Inside Mount Bracket	\$115.55 ea.
	<b>B899-4-00</b> Rail Connector	\$38.12 ea.		<b>B11592-00</b> Flush Ceiling Bracket	\$23.33 ea.
	<b>B11580-XX</b> Square Finial	\$118.76 ea.		Two Piece Connected Snap Carrier w/ Square Base, in plastic sleeve. Use 1 1/4" snap tape	\$1.17 ea.  \$0.97 ea. /box of 1000
	<b>B11581-XX</b> Square Finial w/ Spacer	\$205.43 ea.		2114-25, 59 black 60% fullness, 2 5/8" OC	Colors other than white +10%
	<b>B1254015-XX</b> End Cap Finial	\$67.40 ea.		2111-25, 65 brown, 90 silver 80% fullness, 2 3/8" OC	
	<b>B11570-80-XX</b> Single Wall Bracket	\$218.26ea.	2112-25, 59 black 100% fullness, 2 1/8" OC		
	<b>B11570-2-190-XX</b> Double Wall Bracket	\$261.91 ea.		<b>52002-25</b> 24 gold, 59 black, 65 brown, 90 silver + 10% Slim Line Ball Bearing Carrier	\$0.65 ea.  \$0.53 ea. /box of 1000
	<b>B11473-80-XX</b> Ceiling Bracket/ Invisible Wall Bracket	\$203.63 ea.		<b>B8809-23-00</b> Overlap R <b>B8809-24-00</b> Underlap L 59 black + 10% Plastic Snap Master	\$12.26 ea.  \$10.21 ea. /box of 25
	<b>B11473-15-XX</b> Ceiling Bracket 5/8" Extension	\$89.13 ea.		<b>9040-25</b> Overlap R/L FES Master	\$4.94 ea.  \$4.11 /box of 25
				<b>V799-2-00</b> End Stop	\$0.85 ea.  \$0.70 ea. /box of 100
			<p>Fiberglass batons in 36", 48", 60" and 72" lengths and these colors. See all batons page 23.</p> <div style="display: flex; justify-content: space-around; align-items: center;"> <div style="text-align: center;"> White</div> <div style="text-align: center;"> Satin Brass</div> <div style="text-align: center;"> Black</div> <div style="text-align: center;"> Brown 48" only</div> <div style="text-align: center;"> Bronze</div> <div style="text-align: center;"> Silver</div> </div>		

 **BREAK PACK PRICING**  - Prices with this designation indicate a 20% up charge for broken pack quantities.

# METAL

GLASGOW | DRESDEN | DEVENTER DECO | LISBON | AVEIRO | PORTO | DRESDEN | DEVENTER CRS | FRANKFURT | **STUTTGART**

METAL TRAVERSING STUTTGART C-RAIL



Scan for more information on  
FOREST STUTTGART C-RAIL



29 Satin Nickel C-Rail with Sala End Cap Finial

## AVAILABLE FINISHES XX = finish color



22  
Polished Chrome



29  
Satin Nickel



59  
Black

## STUTTGART C-RAIL

- C-Rail system for one- or two-way pinch pleat or ripplefold drapery.
- Wall or ceiling mount. See bracket count below.
  - Up to 60" = 2 brackets
  - 61-120" = 3 brackets
  - 121-180" = 4 brackets
  - 181-240" = 5 brackets
- Maximum weight is 4 lbs per foot depending on application.

## ASSEMBLED PRICING

Includes rail, end cap finial, carriers, end stop, masters, wall or ceiling brackets and 36" white fiberglass baton (see all batons p. 23). Indicate pinch pleat or ripplefold when ordering. Freight is additional.

STUTTGART C-RAIL	first 4 feet	ea. add'l foot
Single	\$661.65	\$108.77
Double	\$1,323.30	\$217.55

# METAL

GLASGOW | DRESDEN | DEVENTER DECO | LISBON | AVEIRO | PORTO | DRESDEN | DEVENTER CRS | FRANKFURT | **STUTT GART**

C-RAIL	COMPONENT	PRICE	C-RAIL	COMPONENT	PRICE
	<b>B8087057-XX</b> C Rail 19' 7"	\$61.66/ft.		Wheeled Connected Snap Carrier in plastic sleeve <b>2107-25, 59</b> black 60% fullness, 2 5/8" OC <b>2106-25, 59</b> black, <b>90</b> silver 80% fullness, 2 3/8" OC <b>2105-25, 24</b> gold, <b>59</b> black, <b>65</b> brown, <b>90</b> silver 100% fullness, 2 1/8" OC <b>2108-25, 59</b> black 120% fullness, 1 7/8" OC	\$1.46 ea. \$1.20 ea. /roll of 500  Colors other than white +10%
	<b>B899-4-00</b> 1 1/8" & 1 9/16" Rail Connector	\$38.12 ea.		<b>52002-25</b> <b>24</b> gold, <b>59</b> black, <b>65</b> brown, <b>90</b> silver + 10% Slim Line Ball Bearing Carrier	\$0.65 ea. \$0.53 ea. /box of 1000
	<b>B1247057-L-XX</b> <b>B1247057-R-XX</b> Sala End Cap Finial	\$89.44 ea.		<b>52502-25</b> Overlap R <b>52504-25</b> Underlap L <b>59</b> black + 10% Standard Multi-Functional Master Use stiffener w/ exposed baton or hooks w/ hidden baton	\$6.98 ea. \$5.82 ea. /box of 100
	<b>B11473-80-XX</b> Wall/Ceiling Bracket	\$87.60 ea.		<b>52502-25A</b> Overlap R <b>52504-25A</b> Underlap L <b>59A</b> black + 10% Standard Multi-Functional Master w/ snaps	\$8.46 ea. \$7.06 ea. /box of 100
	<b>B11591-00</b> 90° Ceiling Bracket Can be used as recess bracket	\$29.95 ea.		<b>52411-25A</b> Butt R <b>52412-25A</b> Butt L <b>24A</b> gold, <b>59A</b> black, <b>65A</b> brown, <b>90A</b> silver Wheeled Butt Master w/snap adaptor Designed for hidden baton	\$29.94 ea. \$24.94 ea. /box of 50  Colors other than white +10%
	Wheeled Connected Snap Carriers on plastic strip <b>2207-25</b> 60% fullness, 2 5/8" OC <b>2206-25, 59</b> black, <b>90</b> silver 80% fullness, 2 3/8" OC <b>2205-25</b> 100% fullness, 2 1/8" OC <b>2208-25</b> 120% fullness, 1 7/8" OC	\$1.88 ea. \$1.57 ea. /box of 500  Colors other than white, in 80% only, +10%		<b>V799-2-00</b> End Stop	\$0.85 ea. \$0.70 ea. /box of 100
<b>BREAK PACK PRICING</b> - Prices with this designation indicate a 20% up charge for broken pack quantities.		Fiberglass batons in 36", 48", 60" and 72" lengths and these colors. See all batons page 23. <div style="display: flex; justify-content: space-around; align-items: center;"> <div style="text-align: center;"> White</div> <div style="text-align: center;"> Satin Brass</div> <div style="text-align: center;"> Black</div> <div style="text-align: center;"> Brown 48" only</div> <div style="text-align: center;"> Bronze</div> <div style="text-align: center;"> Silver</div> </div>			

# METAL

GLASGOW | DRESDEN | DEVENTER DECO | LISBON | AVEIRO | PORTO | DRESDEN | DEVENTER CRS | FRANKFURT | **STUTT GART**

METAL TRAVERSING STUTT GART OVAL RAIL



Scan for more information on  
FOREST STUTT GART OVAL RAIL



1 1/2" Oval Rail in 22 Polished Chrome with Sona End Cap



2 3/4" Oval Rail in 29 Satin Nickel with Flush Bracket and Sona End Cap



2 3/4" Double Oval Rail in 59 Black with 22 Polished Chrome Sona End Caps

## STUTT GART OVAL RAIL

- 1" & 2 3/4" traversing oval rail system for one- or two-way pinch pleat or ripplefold drapery.
- Wall or ceiling mount. See bracket count below.
  - Up to 60" = 2 brackets
  - 61-120" = 3 brackets
  - 121-180" = 4 brackets
  - 181-240" = 5 brackets
- Maximum weight is 4 lbs per foot depending on application.

### ASSEMBLED PRICING

Includes rail, end cap finial, carriers, end stop, masters, wall or ceiling brackets and 36" white fiberglass baton (see all batons p. 23). Indicate pinch pleat or ripplefold when ordering. Freight is additional.

STUTT GART OVAL RAIL	first 4 feet	ea. add'l foot
1 1/2" Single	\$675.31	\$76.16
1 1/2" Double	\$1,350.63	\$152.32
2 3/4" Single	\$781.16	\$93.18
2 3/4" Double	\$1,562.33	\$186.37

### AVAILABLE FINISHES XX = finish color



# METAL

GLASGOW | DRESDEN | DEVENTER DECO | LISBON | AVEIRO | PORTO | DRESDEN | DEVENTER CRS | FRANKFURT | **STUTT GART**

OVAL	COMPONENT	PRICE	OVAL	COMPONENT	PRICE
	<b>B8084020-XX</b> 1 1/2" Oval Rail 19' 7"	\$38.92/ft.		Wheeled Connected Snap Carriers on plastic strip <b>2207-25</b> 60% fullness, 2 5/8" OC <b>2206-25, 59</b> black, <b>90</b> silver <b>2205-25</b> 80% fullness, 2 3/8" OC <b>2208-25</b> 100% fullness, 2 1/8" OC 120% fullness, 1 7/8" OC	\$1.88 ea. \$1.57 ea. /box of 500  Colors other than white, in 80% only, +10%
	<b>B1254022-XX</b> 1 1/2" Sona End Cap 1/4" Projection	\$71.83 ea.		Wheeled Connected Snap Carrier in plastic sleeve <b>2107-25, 59</b> black 60% fullness, 2 5/8" OC <b>2106-25, 59</b> black, <b>90</b> silver 80% fullness, 2 3/8" OC <b>2105-25, 24</b> gold, <b>59</b> black, <b>65</b> brown, <b>90</b> silver 100% fullness, 2 1/8" OC <b>2108-25, 59</b> black 120% fullness, 1 7/8" OC	\$1.46 ea. \$1.20 ea. /roll of 500  Colors other than white +10%
	<b>B8087022-XX</b> 2 3/4" Oval Rail 19' 7"	\$54.39/ft.		<b>52002-25</b> 24 gold, <b>59</b> black, <b>65</b> brown, <b>90</b> silver + 10% Slim Line Ball Bearing Carrier	\$0.65 ea. \$0.53 ea. /box of 1000
	<b>B1247022-XX</b> 2 3/4" Sona End Cap 1/4" Projection	\$91.63 ea.		<b>52502-25</b> Overlap R <b>52504-25</b> Underlap L <b>59</b> black + 10% Standard Multi-Functional Master Use stiffener w/ exposed baton or hooks w/ hidden baton	\$6.98 ea. \$5.82 ea. /box of 100
	<b>B899-4-00</b> 1 1/8" & 1 9/16" Rail Connector	\$38.12 ea.		<b>52502-25A</b> Overlap R <b>52504-25A</b> Underlap L <b>59A</b> black + 10% Standard Multi-Functional Master w/ snaps	\$8.46 ea. \$7.06 ea. /box of 100
	<b>B11370-80-XX</b> Single Wall Bracket	\$99.06 ea.		<b>52411-25A</b> Butt R <b>52412-25A</b> Butt L <b>24A</b> gold, <b>59A</b> black, <b>65A</b> brown, <b>90A</b> silver Wheeled Butt Master w/snap adaptor Designed for hidden baton	\$29.94 ea. \$24.94 ea. /box of 50  Colors other than white +10%
	<b>B11873-50-XX</b> Ceiling Bracket/ Invisible Wall Bracket	\$102.71 ea.		<b>B8809-23-00</b> Overlap R <b>B8809-24-00</b> Underlap L <b>59</b> black + 10% Plastic Snap Master	\$12.26 ea. \$10.21 ea. /box of 25
	<b>B11873-80-XX</b> Extended Wall/ Ceiling Bracket	\$87.60 ea.		<b>V799-2-00</b> End Stop	\$0.85 ea. \$0.70 ea. /box of 100
	<b>B11870-40-XX</b> 1 1/2" <b>B11870-80-XX</b> 3" Bracket Extensions for B11873-50-XX and B11873-80-XX	\$35.93 ea. \$38.41 ea.		Fiberglass batons in 36", 48", 60" and 72" lengths and these colors. See all batons page 23.	
	<b>B11873-15-XX</b> Ceiling Bracket 5/8" Extension	\$54.57 ea.		White    Satin Brass    Black    Brown 48" only    Bronze    Silver	
	<b>B11592-00</b> Flush Ceiling Bracket	\$23.33 ea.			

**BREAK PACK PRICING** - Prices with this designation indicate a 20% up charge for broken pack quantities.

METAL TRAVERSING STUTT GART OVAL RAIL



## FOREST DECORATIVE WOOD COLLECTIONS

Pole sets, hand drawn traversing, cord draw traversing and motorized (see pages 91-92)

### Valencia 1 3/4"

Pole Sets



### Seville 1 3/8"

Pole Sets





Our wood drapery poles and accessories are made from only the finest solid woods such as ayous and ash. The richness of these woods and lovely finishes applied will add warmth and timeless beauty to any room.

## Cordoba 2"

Pole Sets, Traversing & Motorized



**MOTOR**  
CONTROL  
P. 91-92

## Granada 2 3/4"

Pole Sets, Traversing & Motorized



**MOTOR**  
CONTROL  
P. 91-92

# WOOD

1 3/4" VALENCIA POLE SETS | 1 3/8" SEVILLE POLE SETS | 2" CORDOBA POLE SETS | 2 3/4" GRANADA POLE SETS | TRAVERSING WOOD

WOOD POLES SETS VALENCIA



## VALENCIA COLLECTION

1 3/4" Valencia wood pole sets made from highly grained, strong ash wood. Recommended weight is 4 lbs./ft. depending on application.



Scan for more information on FOREST VALENCIA POLE SETS

### AVAILABLE FINISHES XX = finish color

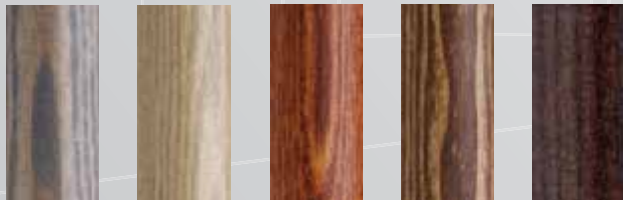

- 80 Driftwood
- 81 Weathered Oak
- 82 Redwood
- 83 Tiger Oak
- 84 Espresso

### VALENCIA COLLECTION POLE & COMPONENTS



**1045SWO-XX**  
1 3/4" Smooth Wood Pole  
Stock Length: 8'  
\$36.16/ft.



**1245WBR-XX**  
Valencia Wall Bracket  
\$38.55 ea.



**1345WRI-XX**  
Valencia Wood Ring  
\$2.70 ea.



# WOOD

1 3/4" VALENCIA POLE SETS | 1 3/8" SEVILLE POLE SETS | 2" CORDOBA POLE SETS | 2 3/4" GRANADA POLE SETS | TRAVERSING WOOD

## VALENCIA COLLECTION (CONTINUED)

Ash wood from France gives this collection a beautifully grained appearance.



80 Driftwood Smooth Pole with Castell Finial



81 Weathered Oak Smooth Pole with Granada Finial



82 Redwood Smooth Pole with Ringed Ball Finial



83 Tiger Oak Smooth Pole with Smooth Ball Finial



84 Espresso Smooth Pole with End Cap Finial

### VALENCIA COLLECTION FINIALS

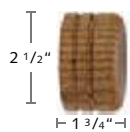

1145WEN-XX  
End Cap Finial  
\$10.79 ea.



1145SMO-XX  
Smooth Ball Finial  
\$23.45 ea.



1145RIN-XX  
Ringed Ball Finial  
\$23.45 ea.



1145GRA-XX  
Granada Finial  
\$18.47 ea.

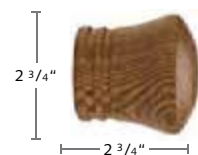

1145CAS-XX  
Castell Finial  
\$19.43 ea.

# WOOD

1 3/4" VALENCIA POLE SETS | **1 3/8" SEVILLE POLE SETS** | 2" CORDOBA POLE SETS | 2 3/4" GRANADA POLE SETS | TRAVERSING WOOD

WOOD POLE SETS SEVILLE



## SEVILLE COLLECTION

1 3/8" Wood pole sets made from strong Ayous wood. Recommended weight is 4 lbs./ft. depending on application.



Scan for more information on FOREST SEVILLE POLE SETS

### AVAILABLE FINISHES XX = finish color

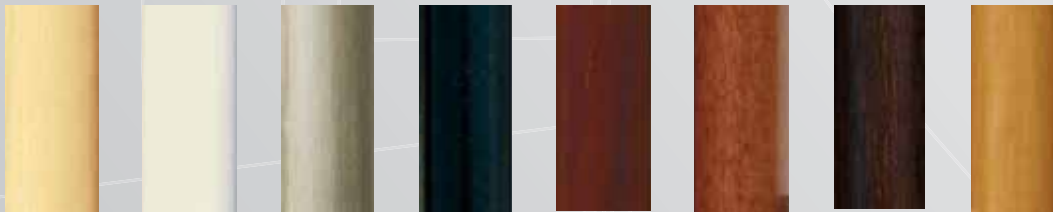

00 Unfinished    25 White    58 Stone    59 Black    70 Hazel    71 Honey    72 Walnut    73 Natural

### SEVILLE COLLECTION POLE & BRACKETS



**1035SWO-XX**  
1 3/8" Smooth Wood Pole  
Stock Length: 13'  
\$7.56/ft.



**1235CYL-XX**  
Cylinder Bracket  
\$14.17 ea.



**1235CLA-XX**  
Classic Open Bracket  
\$16.85 ea.



**1235CEI-XX**  
Ceiling Bracket  
\$14.23 ea.

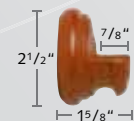

**1235IMB-XX**  
Inside Mount Bracket  
\$10.72 ea.

# WOOD

1 3/4" VALENCIA POLE SETS | 1 3/8" SEVILLE POLE SETS | 2" CORDOBA POLE SETS | 2 3/4" GRANADA POLE SETS | TRAVERSING WOOD

## SEVILLE COLLECTION (CONTINUED)

72 Walnut Pole with Deka Finial



70 Hazel Pole with Redondo Finial



25 White Pole with Country Finial



### SEVILLE COLLECTION FINIALS, RINGS, HOLDBACKS & BATONS

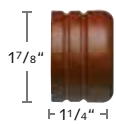

**1135WEN-XX**  
End Cap Finial  
\$6.78 ea.

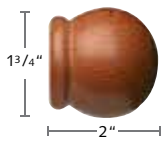

**1135BOL-XX**  
Bola Finial  
\$9.56 ea.

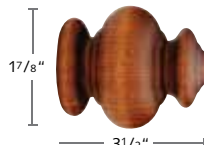

**1135ODI-XX**  
Odiseia Finial  
\$23.56 ea.

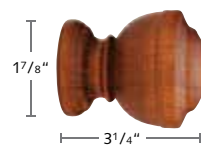

**1135CAL-XX**  
Calice Finial  
\$25.54 ea.

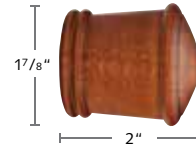

**1135COR-XX**  
Corona Finial  
\$12.00 ea.

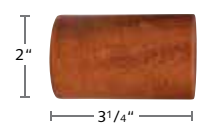

**1135COU-XX**  
Country Finial  
\$25.24 ea.

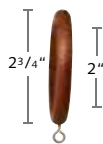

**1335WRI-XX**  
1 3/8" Wood Ring  
w/ Eyelet  
\$2.34 ea.

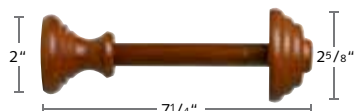

**16WHOLD-XX**  
Wood Holdback  
\$18.56 ea.



**14WLSHI-00**  
Rosette w/  
Carved Post  
\$23.65 ea.  
unfinished



**19WWAND-XX**  
40" Wood Baton  
\$18.94 ea. unfinished  
\$23.31 ea. finished

See all batons p. 23



**19CWAND-XX**  
40" Modern Wood Baton  
\$18.94 ea. unfinished  
\$23.31 ea. finished

See all batons p. 23

# WOOD

1 3/4" VALENCIA POLE SETS | 1 3/8" SEVILLE POLE SETS | **2" CORDOBA POLE SETS** | 2 3/4" GRANADA POLE SETS | TRAVERSING WOOD

WOOD POLE SETS CORDOBA



## CORDOBA COLLECTION

2" Wood pole sets made from strong Ayous wood.  
Recommended weight is 4 lbs./ft. depending on application.



**MOTOR CONTROL**  
P. 91-92



Scan for more information on  
FOREST CORDOBA POLE SETS

**AVAILABLE FINISHES** XX = finish color Not all components are stocked in Antiqued finishes. Please call for availability.



00 Unfinished	25 White	37 Sand Gold Antiqued* smooth poles only	45 Leather Antiqued* smooth poles only	58 Stone smooth poles only	59 Black	70 Hazel	71 Honey	72 Walnut	73 Natural
------------------	-------------	------------------------------------------------------	----------------------------------------------------	-------------------------------------	-------------	-------------	-------------	--------------	---------------

## CORDOBA COLLECTION POLES & BRACKETS



**1051SWO-XX**  
2" Smooth  
Stock Length: 14'  
\$16.94/ft. unfinished  
\$19.21/ft. finished  
\$28.77/ft. antiqued



**1051RWO-XX**  
2" Reeded  
Stock Length: 14'  
Not avail in 37, 45 or 58  
\$18.80/ft. unfinished  
\$24.48/ft. finished



**1251WBR-XX**  
Wood Bracket  
\$31.21 ea. unfinished  
\$38.55 ea. finished  
\$56.42 ea. antiqued



**1251EUR-XX**  
Euro Wood Bracket  
\$19.94 ea. unfinished  
\$26.03 ea. finished  
\$40.03 ea. antiqued



**1251WIM-XX**  
Open Inside Mount  
Bracket  
\$23.88 ea. unfinished  
\$29.45 ea. finished  
\$42.58 ea. antiqued

**CORDOBA COLLECTION (CONTINUED)**

71 Honey Smooth Pole with Zenith Finial



58 Stone Smooth Pole with Ringed Ball Finial



72 Walnut Reeded Pole with Odiseia Finial



**CORDOBA COLLECTION FINIALS, RINGS, HOLDBACKS & BATONS**



**1151WEN-XX**  
End Cap Finial  
\$11.10 ea. unfinished  
\$13.86 ea. finished  
\$18.30 ea. antiqued

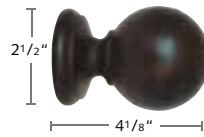

**1151SMO-XX**  
Smooth Ball Finial  
\$28.30 ea. unfinished  
\$37.24 ea. finished



**1151RIN-XX**  
Ringed Ball Finial  
\$29.46 ea. unfinished  
\$37.46 ea. finished  
\$53.44 ea. antiqued



**1151FLU-XX**  
Fluted Ball Finial  
\$42.48 ea. unfinished  
\$52.31 ea. finished

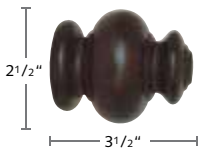

**1151ODI-XX**  
Odiseia Finial  
\$30.03 ea. unfinished  
\$44.58 ea. finished

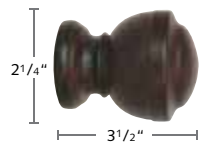

**1151CAL-XX**  
Calice Finial  
\$31.25 ea. unfinished  
\$45.72 ea. finished

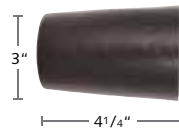

**1151ZEN-XX**  
Zenith Finial  
\$35.31 ea. unfinished  
\$52.42 ea. finished

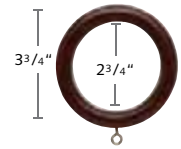

**1351WRI-XX**  
2" Wood Ring  
w/ Eyelet  
\$4.04 ea. unfinished  
\$5.43 ea. finished  
\$8.92 ea. antiqued



**16WHOLD-XX**  
Wood Holdback  
\$18.56 ea.



**14WLSHI-00**  
Rosette w/ Carved Post  
\$23.65 ea. unfinished



**19WWAND-XX**  
40" Wood Baton  
\$18.94 ea. unfinished  
\$23.31 ea. finished  
\$43.41 ea. antiqued

See all batons p. 23



**19CWAND-XX**  
40" Modern Wood Baton  
\$18.94 ea. unfinished  
\$23.31 ea. finished  
\$43.41 ea. antiqued

See all batons p. 23

# WOOD

1 3/4" VALENCIA POLE SETS | 1 3/8" SEVILLE POLE SETS | 2" CORDOBA POLE SETS | **2 3/4" GRANADA POLE SETS** | TRAVERSING WOOD

WOOD POLE SETS GRANADA



## GRANADA COLLECTION

2 3/4" Wood pole sets made from strong Ayous wood.  
Recommended weight is 4 lbs./ft. depending on application.



**MOTOR CONTROL**  
P. 91-92



Scan for more information on  
FOREST GRANADA POLE SETS

### AVAILABLE FINISH XX = finish color



00  
Unfinished

## CORDOBA COLLECTION POLES & BRACKETS



**1072SWO-00**  
2 3/4" Smooth  
Stock Length: 13'  
\$29.50/ft.



**1072RWO-00**  
2 3/4" Reeded  
Stock Length: 13'  
\$31.05/ft.

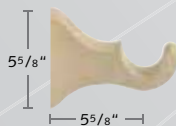

**1272WBR-00**  
Wood Bracket  
\$33.81 ea.



**1272EUR-00**  
Euro Wood Bracket  
\$40.28 ea.



**1272WIM-00**  
Open Inside Mount Bracket  
\$38.07 ea.

# WOOD

1 3/4" VALENCIA POLE SETS | 1 3/8" SEVILLE POLE SETS | 2" CORDOBA POLE SETS | **2 3/4" GRANADA POLE SETS** | TRAVERSING WOOD

## GRANADA COLLECTION (CONTINUED)



The Granada Collection is stocked unfinished. Call sales for pricing on your custom finish request.

### GRANADA COLLECTION FINIALS, RINGS, HOLDBACKS & BATONS



**1172WEN-00**  
End Cap Finial  
\$13.61 ea.



**1172SMO-00**  
Smooth Ball Finial  
\$44.94 ea.

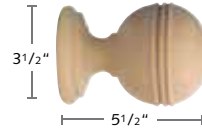

**1172RIN-00**  
Ringed Ball Finial  
\$46.79 ea.



**1172FLU-00**  
Fluted Ball Finial  
\$60.94 ea.

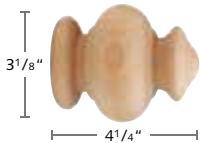

**1172ODI-00**  
Odiseia Finial  
\$44.73 ea.

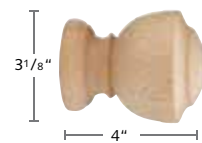

**1172CAL-00**  
Calice Finial  
\$45.93 ea.



**1172TRA-00**  
Traditional Finial  
\$62.48 ea.

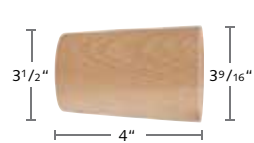

**1172ZEN-00**  
Zenith Finial  
\$52.79 ea.

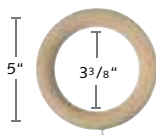

**1372WRI-00**  
2 3/4" Wood Ring  
w/ Eyelet  
\$15.89 ea.



**16WHOLD-00**  
Wood Holdback  
\$18.56 ea.



**14WLSHI-00**  
Rosette w/ Carved Post  
\$23.65 ea.



**19WWAND-00**  
40" Wood Baton  
\$18.94 ea.

See all batons p. 23



**19CWAND-00**  
40" Modern Wood Baton  
\$18.94 ea.

See all batons p. 23

# WOOD

1 3/4" VALENCIA POLE SETS | 1 3/8" SEVILLE POLE SETS | 2" CORDOBA POLE SETS | 2 3/4" GRANADA POLE SETS | **TRAVERSING WOOD**

WOOD TRAVERSING SYSTEMS



Scan for more information on FOREST WOOD TRAVERSING

## WOOD TRAVERSING

- 2" & 2 3/4" heavy duty hand, baton or cord draw traversing system for one- or two-way pinch pleat or ripplefold drapery.
- Maximum weight is 4 lbs per foot depending on application.

### ASSEMBLED PRICING

Includes wood pole fascia, assembled track, wall brackets (bracket cover optional and available for purchase separately), customer's choice of finials on pages 64 & 66, c-ring where specified, and 36" white fiberglass baton (see all batons p. 23). Indicate pinch pleat or ripplefold when ordering. Freight is additional.



72 Walnut wood fascia over brown CS Track. Carriers are also available in colors.



**MOTOR CONTROL**  
P. 91-92

WOOD TRAVERSING	TRAVERSING first 4 feet	TRAVERSING ea. add'l ft.	C-RING first 4 feet	C-RING ea. add'l ft.
2" Cordoba Single Unfinished	\$374.17	\$30.19	\$544.33	\$53.59
2" Cordoba Single Finished	\$442.43	\$36.94	\$660.64	\$67.62
2" Cordoba Double Unfinished	\$420.93	\$40.86	\$712.98	\$64.23
2" Cordoba Double Finished	\$479.11	\$47.59	\$831.57	\$78.27
2 3/4" Granada Single Unfinished	\$430.30	\$37.67	\$625.96	\$114.80
2 3/4" Granada Single Finished	\$508.80	\$50.11	\$759.74	\$123.80
2 3/4" Granada Double Unfinished	\$484.07	\$47.91	\$822.64	\$125.43
2 3/4" Granada Double Finished	\$563.90	\$61.74	\$956.32	\$137.98

### AVAILABLE FINISHES

XX = finish color \*Not all components are stocked in antiqued finishes. Please call for availability.



00 Unfinished



25 White



37 Sand Gold Antiqued\* smooth poles only



45 Leather Antiqued\* smooth poles only



58 Stone smooth poles only



59 Black



70 Hazel



71 Honey



72 Walnut



73 Natural



# WOOD

1 3/4" VALENCIA POLE SETS | 1 3/8" SEVILLE POLE SETS | 2" CORDOBA POLE SETS | 2 3/4" GRANADA POLE SETS | **TRAVERSING WOOD**

## TRAVERSING WOOD POLES

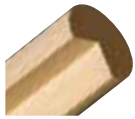

**1051RSW-XX**  
2" CORDOBA  
Routed Smooth  
Stock Length: 14'

**1072RSW-00**  
2 3/4" GRANADA  
Routed Smooth  
Stock Length: 13'



**1051RRW-XX**  
2" CORDOBA  
Routed Reeded  
Stock Length: 14'

**1072RRW-00**  
2 3/4" GRANADA  
Routed Reeded  
Stock Length: 13'

## TRAVERSING WOOD TRACKS

Use CS Track in white, black, brown or silver with color coordinating components, or use cord draw CCS Track in white, brown or silver with color coordinating components. Use with pinch pleat or ripplefold draperies. See all carrier and master options on pages 5-6 for CS and page 8 for CCS.

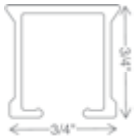
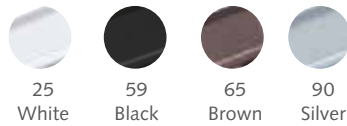

**CS® CONTRACT SYSTEM**  
Aluminum extrusion, powder coated and lubricated.  
Available in 25 white, 59 black, 65 brown and 90 silver.

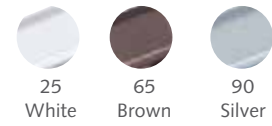

**CCS® CONTRACT CORD SYSTEM**  
Aluminum extrusion, white, powder coated, lubricated. Available in 25 white, 65 brown and 90 silver. All corded systems include child safety tension device.

## TRAVERSING WOOD BRACKETS



**3280-25**  
59 black, 65 brown, 90 silver  
3" Single Wall Bracket heavy duty  
projection 2 1/2"  
\$11.57 ea. \$9.64 ea./box of 20

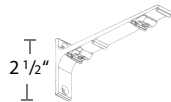

**3281-25**  
59 black, 65 brown  
6" Double Wall Bracket heavy duty  
projection 1 1/2", 5 1/2"  
\$16.58 ea. \$13.82 ea./box of 15



**3284-25**  
65 brown  
10" Triple Wall Bracket heavy duty  
projection 2", 6 5/8", 9 5/16"  
\$30.74 ea. \$25.62 ea./box of 10



**32801-25**  
59 black, 90 silver + 10%  
Wall Bracket Cover, optional  
\$2.98 ea., \$2.49 ea./box of 50

## OPTIONAL C-RINGS



**1352WRI-XX**  
C-Ring  
Choose white, black or brown carrier  
\$8.76 ea.



**52007-25**  
59 black, 65 brown + 10%  
C-Ring Carrier  
\$0.48 ea.



**52405-90** Overlap R  
**52406-90** Underlap L  
65 brown  
C-Ring Master Carrier  
\$6.43 ea.

## BATON OPTIONS See all batons p. 23



**19WWAND-XX**  
40" Wood Baton  
\$18.94 ea. unfinished  
\$23.31 ea. finished  
\$43.41 ea. antiqued



**19CWAND-XX**  
40" Modern Wood Baton  
\$18.94 ea. unfinished  
\$23.31 ea. finished  
\$43.41 ea. antiqued

Fiberglass batons come in 36", 48", 60" and 72" lengths and colors below. See all batons p. 23

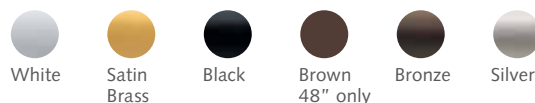



## FOREST MOTORIZED COLLECTIONS

A variety of track systems, roman shades, decorative metal and decorative wood

**FMS®**

HEAVY DUTY TRACK SYSTEM

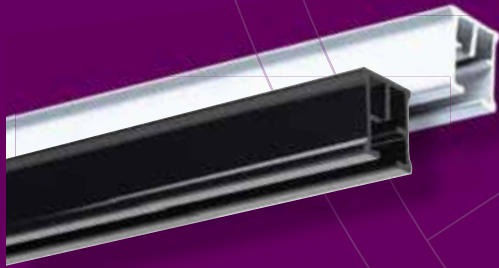

**RMS**

RECESSED TRACK SYSTEM



**BCS®**

CONTRACT BLIND SYSTEM



**DRESDEN**

1 1/8" & 1 9/16" DECORATIVE METAL





Our wide range of control options make finding a fit for your room easy; controlling the drapery by hand, remote or by building automation system. When controlling motorized drapery with your smart phone or tablet, you can create and schedule customized room schedules that allow your drapes to operate on their own throughout the day.

## **DSXL LED** DESIGNER TRACK WITH LED LIGHTING



## **RBS®** ROMAN BLIND SYSTEM



## **DEVENTER MRS®** 1 1/8" DECORATIVE METAL



## **CORDOBA/GRANADA** 2" & 2 3/4" DECORATIVE WOOD



# MOTORIZATION

SHUTTLE MOTOR SPECIFICATIONS | FMS | RMS | DSXL LED | RBS | BCS | DRESDEN | DEVENTER MRS | CORDOBA/GRANADA



**SMART HOME**  
READY



**APP**  
CONTROL



**WIRELESS**  
REMOTE



**TOUCH**  
CONTROL



Hey Google



Hey Siri



Hey Alexa



## SHUTTLE® HD (M)

## SHUTTLE® L

## SHUTTLE® ECO (S)



### SPECIFICATIONS

VOLTAGE SHUTTLE RECEIVER	24V DC Internal, optional	100-240V, 50-60Hz 0.8A <b>Internal</b>	24V DC Internal
POWER SUPPLY	External, 100-240V AC - 1.5A, 50-60Hz; Output 24V DC - 2.7A	Internal	External, 100-240V AC - 0.8A, 50-60Hz; Output 24V DC - 2.5A
MAX POWER	65W	40W	40W
TORQUE	1.5 Nm	1.0 Nm	1.0 Nm
TRAVEL SPEED	5.5" per second standard 7" per second maximum	5.5" per second standard 7" per second maximum	5.5" per second standard 7" per second maximum
NOISE LEVEL	< 40 dB(A)	< 40 dB(A)	< 40 dB(A)
MAXIMUM WEIGHT	160 lbs per motor 120 lbs per motor - curved track	100 lbs per motor 90 lbs per motor - curved track	100 lbs per motor 90 lbs per motor - curved track
DIMENSIONS	2.76" x 1.97" x 9.5"	2.76" x 1.97" x 11"	2.76" x 1.97" x 7.5"
CERTIFICATIONS/MARKINGS	CE/FCC/DOE	CE/FCC/DOE	CE/FCC/DOE
COLOR OPTIONS	White / Black	White	White

### FEATURES

TOUCH CONTROL TECHNOLOGY	✓	✓	✓
INTEGRATED EMERGENCY CONTROL	✓	✓	✓
RF COMMUNICATION STANDARD	✓	✓	✓
Z-WAVE COMMUNICATION	-	✓	-
AUTOMATION SYSTEM COMPATIBLE	✓ using RS485 & dry contacts	✓ using RS485 & dry contacts	✓ using RS485 & dry contacts
WI-FI COMPATIBLE	✓	✓	✓
WORKS WITH DS-XL LED DIMMER	✓	✓	✓
WORKS WITH WIRELESS CONNECTOR	✓	✓	✓
CAN BE USED WITH CURVED TRACK	✓	✓	✓
PLUG & PLAY	✓	✓	✓
WARRANTY	10 Years	10 Years	10 Years

# MOTORIZATION

SHUTTLE MOTOR SPECIFICATIONS | FMS | RMS | DSXL LED | RBS | BCS | DRESDEN | DEVENTER MRS | CORDOBA/GRANADA



## SMART DEVICE CONNECTIVITY

	Shuttle HD & ECO	Shuttle L	Shuttle iOn	Atlantis & BCS	RBS	Forest Connect app	Google Home	Apple Homekit	Amazon Alexa	Google Assistant	Apple Siri	Voice control
Forest Wireless Connector* One way transmitter to control drapery by third party app or by home automation. (433Mhz)	●	●	●	●	●		●	●	●	●	●	●
Forest Wi-Fi Dongle with the Forest Connect app	●	●				●	●		●	●	●	●
110 Volt hardwired building management system		●		●								
24Vdc (Plug-in transformer to 110 Volt AC outlet)	●				●							

\* Use Fibaro, Mi Casa Verde or a Samsung Smartthings Hub with the Forest Wireless Connector when integrating with Google Home, Apple Homekit, Amazon Alexa, Google Assistant or Apple Siri.

## SHUTTLE® iOn



### SPECIFICATIONS

VOLTAGE SHUTTLE	14.8V DC
RECEIVER	Internal
BATTERY	Lithium iOn battery + charger (3-4 months between charges)
MAX POWER	30W
TORQUE	1.0 Nm
TRAVEL SPEED	5.5" per second standard
NOISE LEVEL	< 40 dB(A)
MAXIMUM WEIGHT	55 lbs per motor 40 lbs per motor - curved track
DIMENSIONS	2" x 3" x 12.25"
CERTIFICATIONS/MARKINGS	CE/FCC/DOE
COLOR OPTIONS	White

### FEATURES

TOUCH CONTROL TECHNOLOGY	✓
INTEGRATED EMERGENCY CONTROL	✓
RF COMMUNICATION STANDARD	✓
Z-WAVE COMMUNICATION	-
AUTOMATION SYSTEM COMPATIBLE	✓ using RS485 & dry contacts
WI-FI COMPATIBLE	✓
WORKS WITH DS-XL LED DIMMER	✓
WORKS WITH WIRELESS CONNECTOR	✓
CAN BE USED WITH CURVED TRACK	✓
PLUG & PLAY	✓
WARRANTY	10 Years on motor 2 years on battery pack

Our wide variety of control options make finding a fit for your windows easy – controlling the drapes by hand, remote or even by home automation system. Controlling the motorized system with your smart phone or tablet, you can create and schedule customized room scenes that allow your drapes to operate on their own throughout the day no matter where you are.



#### FOREST DIAMOND SENSE REMOTE

15-channel remote controls up to 15 motors individually and together, with a timer or manually. Range up to 98 feet. Wall mounted holder included.



#### FOREST WI-FI DONGLE

With the Forest Wi-Fi Dongle, you can control your motorized system with your smart phone or tablet using the Forest Connect app, or by voice command when integrated with Google Home, Amazon Echo and Siri.



#### FOREST WIRELESS CONNECTOR

With the Wireless Connector make your new or existing Shuttle motorized drapery system "smart". Add a smart plug and use with Apple Homekit, Google Assistant, or Amazon Alexa. Also, easily incorporate with building management systems, including dry contact controls.

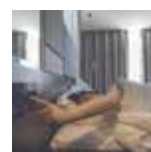

#### BUILDING AUTOMATION / HOTEL ROOM CONTROLS

All 4 Forest Shuttles can be connected to any building automation system, by relay control.

# MOTORIZATION

SHUTTLE MOTORS | **FMS** | RMS | DSXL LED | RBS | BCS | DRESDEN | DEVENTER MRS | CORDOBA/GRANADA

MOTORIZATION FMS TRACK



Scan for more information on the FMS Motorized Track System

## FMS® FOREST MOTORIZED SYSTEM

- The original Forest motorized track, aluminum extrusion, white, powder coated and lubricated with a patented process. Ultra-quiet and smooth operation for contract or residential applications.
- Track can be bent or curved. An actual size template is required. See pages 23-24 for more information.
- Maximum weight is 6 lbs/ft.
- Motorize with any Forest Shuttle. See all motor specifications on pages 67-68. All Forest Shuttle motors include a 10 year warranty.
- Control drapes with a gentle tug, wall switch remote, any home automation system or by smart phone app.

### ASSEMBLED PRICING











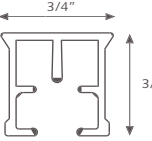
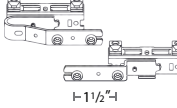
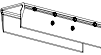



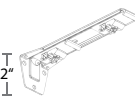

Includes track, masters, pinchpleat or ripplefold carriers, brackets, motor, power supply, and Diamond Sense remote or wall switch. Add 10% for black. Freight is additional.

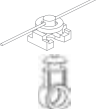
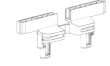
FMS MOTORIZED TRACK	first 4 feet	ea. add'l foot
Shuttle HD (M) white	\$1,880.01	\$29.35
Shuttle HD (M) black	\$2,068.01	\$32.28
Shuttle L	\$1,671.58	\$29.35
Shuttle Eco (S)	\$1,710.99	\$29.35
Shuttle iOn	\$2,478.01	\$29.35

See all motor specifications on pages 67-68.

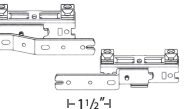
# MOTORIZATION

SHUTTLE MOTORS | **FMS** | RMS | DSXL LED | RBS | BCS | DRESDEN | DEVENTER MRS | CORDOBA/GRANADA

FMS	COMPONENT	PRICE	FMS	COMPONENT	PRICE
●	 <b>51323-25</b> white <b>59</b> black +10% FMS Track 23' x 10 tracks per bundle bundle = 230'	\$5.55/ft.	●	 <b>52508-25A</b> Overlap Right <b>52509-25A</b> Underlap Left <b>59A</b> black +10% Belt Master Carrier with snaps	\$14.59 ea. \$12.16 ea. /box of 100
●	 <b>3906-25</b> <b>59</b> black +10% Track Connector and Key <b>3904-00</b>	\$16.16 ea.	●	 <b>52410-25</b> Butt Right <b>52409-25</b> Butt Left <b>59</b> black +10% Butt Master Carrier with snaps	\$16.96 ea. \$14.12 ea. /box of 50
●	 <b>3003-25</b> <b>59</b> black +10% HD Klick Ceiling Bracket	\$2.10 ea. \$1.75 ea. /box of 100	●	 <b>2552-25</b> 6" Extension Arm for master Use w/ two one-way draw	\$11.44 ea. \$9.54 ea. /box of 50
●	 <b>30031-25</b> <b>59</b> black +10% Ceiling Bracket Cover	\$0.87 ea. \$0.73 ea. /box of 100	●	 <b>52925-25</b> Shuttle HD (M) white <b>52925-59</b> Shuttle HD (M) black <b>52923-25</b> Shuttle L <b>52939-25</b> Shuttle Eco (S) <b>52926-25</b> Shuttle iOn See motor specs on pages 67-68	\$1,061.84 ea. \$1,168.04 ea. \$853.41 ea. \$860.07 ea. \$1,659.84 ea. 1/box
●	 <b>53202-25</b> <b>59</b> black +10% 3" Klick Single Wall Bracket with wide base adjusts 3" - 4 1/2"	\$3.10 ea. \$2.59 ea. /box of 100	●	 <b>52928-25</b> 7' 6" power cord <b>52934-25</b> 16' power cord Includes 24 v Power Supply	\$135.02 ea. 1/box
●	 <b>53206-25</b> <b>59</b> black +10% 6" Klick Double Wall Bracket with wide base adjusts 2 1/2" - 4" and 6" - 7 1/2"	\$5.10 ea. \$4.24 ea. /box of 50	●	 <b>9012-25</b> Transport Belt Kevlar reinforced	\$11.12/ft. \$9.25/ft. /roll of 328 ft.
●	 Two Piece Connected Snap Carrier w/ Square Base, in plastic sleeve. Use 1 1/4" snap tape <b>2114-25, 59</b> black 60% fullness, 2 5/8" OC <b>2111-25, 65</b> brown, <b>90</b> silver 80% fullness, 2 3/8" OC <b>2112-25, 59</b> black 100% fullness, 2 1/8" OC <b>2115-25, 59</b> black 120% fullness, 1 7/8" OC	\$1.17 ea. \$0.97 ea. /roll of 500  Colors other than white +10%	●	 <b>52512-25</b> white <b>59</b> black +10% Transport Belt Connector	\$11.51 ea. \$9.62 ea. /box of 50
●	 <b>52008-25</b> <b>59</b> black +10% Slim Line Klick Carrier Draperies hang to conceal track	\$1.03 ea. \$0.86 ea. /box of 250	●	 <b>52903-25</b> <b>59</b> black +10% Motor Pulley Connects motor to track	\$90.93 ea. 1/box
●	 <b>52009-25</b> Ball Bearing Carrier for motorization	\$1.46 ea. \$1.20 ea. /box of 250	●	 <b>52910-25</b> <b>59</b> black +10% Return Pulley	\$33.95 ea. 1/box
●	 <b>52508-25</b> Overlap Right <b>52509-25</b> Underlap Left <b>59</b> black +10% Belt Master Carrier	\$12.31 ea. \$10.27 ea. /box of 100	●	 <b>52931-25D</b> white <b>59D</b> black +10% Diamond Sense Remote RF, 15 channel w/ holder, Range 98'	\$344.48 ea. 1/box
			●	 <b>52933-25</b> white <b>59</b> black +10% Diamond Sense Wall Switch 15 channel	\$169.55 ea. 1/box
			●	 <b>52947-25</b> Wireless Connector One-way transmitter to control drapery by third party app or home automation. Works with all Forest Shuttle & tubular motors.	\$213.35 ea. 1/box Includes smart plug
			●	 <b>52948-25</b> <b>59</b> black +10% Wi-Fi Dongle Bi-directional communication using Forest Connect app. Use with Forest Shuttle motors.	\$210.53 ea. 1/box

**BREAK PACK PRICING** - Prices with this designation indicate a 20% up charge for broken pack quantities.

MOTORIZATION FMS TRACK

# MOTORIZATION

SHUTTLE MOTORS | FMS | **RMS** | DSXL LED | RBS | BCS | DRESDEN | DEVENTER MRS | CORDOBA/GRANADA



Scan for more information on the FOREST RMS Recessed Motorized System



## RMS RECESSED MOTORIZED SYSTEM



- Heavy duty aluminum extrusion, white, powder coated and lubricated with a patented process. Ultra-quiet and smooth operation for contract or residential applications.
- Maximum weight is 8 lbs/ft.
- Ultra-quiet, smooth operation with any Forest Shuttle motor.
- All Forest motors and tracks come with a 10-year warranty.



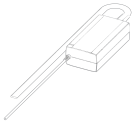

### ASSEMBLED PRICING

Includes track, masters, pinchpleat or ripplefold carriers, recess profile, fixing strip, wedge, motor, pulley, cover plate, power supply, and Diamond Sense remote or Diamond Sense wall switch. Freight is additional.

RMS SYSTEM	first 4 feet	ea. add'l foot
Shuttle HD (M) white	\$1,968.41	\$95.00
Shuttle HD (M) black	\$2,165.25	\$104.51
Shuttle L	\$1,814.73	\$95.00
Shuttle Eco (S)	\$1,975.13	\$95.00
Shuttle iOn	\$2,709.56	\$95.00

See all motor specifications on pages 67-68.

RMS	COMPONENT	PRICE
	<b>52925-25</b> Shuttle HD (M) <b>52925-59</b> Shuttle H (M) black <b>52923-25</b> Shuttle L <b>52939-25</b> Shuttle Eco (S) <b>52926-25</b> Shuttle iOn See motor specs on pages 67-68	\$1,061.84 ea. \$1,168.04 ea. \$853.41 ea. \$860.07 ea. \$1,659.84 ea. 1/box
	<b>52928-25</b> Power Cord, 7' 6" <b>52934-25</b> Power Cord, 16' includes 24 volt power supply	\$135.02 ea. 1/box
	<b>52931-25D</b> white <b>59D</b> black +10% Diamond Sense Remote RF, 15 channel w/ holder, range 98'	\$344.48 ea. 1/box

RMS	COMPONENT	PRICE
	<b>52933-25</b> white <b>59</b> black +10% Diamond Sense Wall Switch 15 channel	\$169.55 ea. 1/box
	<b>52947-25</b> Wireless Connector One way transmitter to control drapery by third party app or by home automation. Works with all Forest Shuttle & tubular motors.	\$213.35 ea. 1/box Includes smart plug
 	<b>52948-25</b> <b>59</b> black +10% Wi-Fi Dongle Bi-directional communication using Forest Connect app. Use with Forest Shuttle motors.	\$210.53 ea. 1/box



# MOTORIZATION

SHUTTLE MOTORS | FMS | **RMS** | DSXL LED | RBS | BCS | DRESDEN | DEVENTER MRS | CORDOBA/GRANADA

MOTORIZATION RECESSED TRACK

RMS	COMPONENT	PRICE	RMS	COMPONENT	PRICE
	<b>51623-25</b> RMS Track white 23' x 10 tracks/bundle bundle = 230'	\$11.79/ft.		Two Piece Connected Snap Carrier w/ Square Base, in plastic sleeve. Use 1 1/4" snap tape <b>2114-25, 59</b> black 60% fullness, 2 5/8" OC <b>2111-25, 65</b> brown, <b>90</b> silver <b>2112-25, 59</b> black 80% fullness, 2 3/8" OC <b>2112-25, 59</b> black 100% fullness, 2 1/8" OC <b>2115-25, 59</b> black 120% fullness, 1 7/8" OC	\$1.17 ea. \$0.97 ea. /roll of 500  Colors other than white +10%
	<b>3803-25</b> Track Connector	\$10.24 ea. \$8.53 ea. /box of 100		<b>9112-25</b> Transport Belt	\$7.09/ft. \$5.90/ft. /roll of 328 ft.
	<b>51723-25</b> Recess Profile, 23' Order same length as track	\$15.59/ft.		<b>51724-25</b> Recess Profile Fixing Strip, 23' Order 6" shorter than track	\$3.28/ft.
	<b>53914-25</b> Recess Profile Wedge Order 1 per track	\$4.59 ea. \$3.82 ea. /box of 10		<b>53903-25</b> Motor Pulley Connects motor to track	\$77.24 ea. 1/box
	<b>53908-25</b> Overlap Right <b>53909-25</b> Underlap Left FMS Plus Master Carrier	\$37.14 ea. \$30.95 ea. /box of 10		<b>53910-25</b> Return Pulley	\$38.60 ea. 1/box
	<b>52008-25</b> Slim Line Klick Carrier Draperies hang to conceal track	\$1.03 ea. \$0.86 ea. /box of 250		<b>53911-25</b> Upside Down Pulley	\$77.24 ea. 1/box
	<b>52009-25</b> Ball Bearing Carrier for motorization	\$1.46 ea. \$1.20 ea. /box of 250		<b>53912-25</b> Cover Plate for Recess Motor and Return Pulley	\$4.21 ea. 1/box
				<b>53913-25</b> Cover Plate for Recess Motor, Upside Down Motor, and Return Pulley	\$3.54 ea. 1/box

**BREAK PACK PRICING** - Prices with this designation indicate a 20% up charge for broken pack quantities.

# MOTORIZATION

SHUTTLE MOTOR SPECIFICATIONS | FMS | RMS | **DSXL LED** | RBS | BCS | DRESDEN | DEVENTER MRS | CORDOBA/GRANADA

MOTORIZATION DSXL LED



Scan for more information on the FOREST DSXL Motorized System



## DSXL® LED MOTORIZED DESIGN SYSTEM + LED LIGHTING

- Elegantly shaped aluminum extrusion, white, powder coated and lubricated with a patented process. LED lighting lights up the backside of drapery or the track itself. Ultra-quiet and smooth operation for contract or residential applications.
- LED strips have low energy consumption, are eco-friendly, dimmable. Lifespan is 30,000 hours.
- Maximum weight is 3 lbs/ft.
- Motorize with any Forest Shuttle. See all motor specifications on pages 67-68.
- Control drapes with a gentle tug, wall switch remote, any home automation system or by smart phone app.

### ASSEMBLED PRICING

Includes track, masters, pinchpleat or ripplefold carriers, brackets, lighting components, motor, power supply, and Diamond Sense remote or wall switch. Freight is additional.











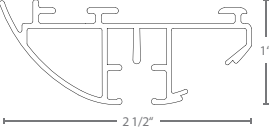













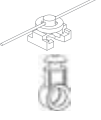





DSXL MOTORIZED	first 4 feet	ea. add'l foot
Shuttle HD (M) white	\$3,013.58	\$110.73
Shuttle L	\$2,805.08	\$110.73
Shuttle Eco (S)	\$2,587.43	\$110.73
Shuttle iOn	\$3,611.51	\$110.73

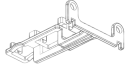

See all motor specifications on pages 67-68.

# MOTORIZATION

SHUTTLE MOTOR SPECIFICATIONS | FMS | RMS | **DSXL LED** | RBS | BCS | DRESDEN | DEVENTER MRS | CORDOBA/GRANADA

MOTORIZATION DSXL LED

DSXL LED	COMPONENT	PRICE	DSXL LED	COMPONENT	PRICE
	<b>3219-25</b> DSXL LED Motorized Track white 19' x 10 tracks per bundle bundle = 190'	\$17.32/ft.		<b>52928-25</b> 7' 6" power cord <b>52934-25</b> 16' power cord Includes 24 v Power Supply	\$135.02 ea. 1/box
				<b>9012-25</b> Transport Belt Kevlar reinforced	\$11.12/ft.  \$9.25/ft. /roll of 328 ft.
	<b>2311-25</b> DSXL Track Connector	\$13.44 ea.  \$11.20 ea. /box of 15		<b>52512-25</b> white Transport Belt Connector	\$11.51 ea.  \$9.62 ea. /box of 50
	<b>2302-25</b> DSXL Swivel Ceiling Bracket	\$2.64 ea.  \$2.20 ea. /box of 100		<b>3203-25</b> Motor Pulley Connects motor to track	\$32.33 ea. 1/box
	<b>2301-25</b> DSXL Wall Bracket w/ Swivel	\$40.72 ea.  \$33.94 ea. /box of 5		<b>3204-25</b> Return Pulley	\$13.19 ea. 1/box
	Two Piece Connected Snap Carrier w/ Square Base, in plastic sleeve. Use 1 1/4" snap tape <b>2114-25, 59</b> black 60% fullness, 2 5/8" OC <b>2111-25, 65</b> brown, <b>90</b> silver 80% fullness, 2 3/8" OC <b>2112-25, 59</b> black 100% fullness, 2 1/8" OC <b>2115-25, 59</b> black 120% fullness, 1 7/8" OC	\$1.17 ea.  \$0.97 ea. /roll of 500 Colors other than white +10%		<b>52931-25D</b> white <b>59D</b> black +10% Diamond Sense Remote RF, 15 channel w/ holder, Range 98'	\$344.48 ea. 1/box
				<b>52933-25</b> white <b>59</b> black +10% Diamond Sense Wall Switch 15 channel	\$169.55 ea. 1/box
	<b>52008-25</b> Slim Line Klick Carrier Draperies hang to conceal track	\$1.03 ea.  \$0.86 ea. /box of 250		<b>52947-25</b> Wireless Connector One-way transmitter to control drapery by third party app or by home automation. Use with Forest Shuttle & tubular motors.	\$213.35 ea. 1/box Includes smart plug
	<b>52009-25</b> Ball Bearing Carrier for motorization	\$1.46 ea.  \$1.20 ea. /box of 250		<b>52948-25</b> <b>59</b> black +10% Wi-Fi Dongle Bi-directional communication using Forest Connect app. Use with Forest Shuttle motors.	\$210.53 ea. 1/box
	<b>9040-25</b> FES Butt Master	\$4.94 ea.  \$4.11 ea. /box of 25		<b>3000-00</b> LED Strip, 3000k/24v 30,000 hr lifespan, dimmable	\$1,433.41 ea. /19' strip \$72.54/ft.
	<b>52925-25</b> Shuttle HD (M) white <b>52923-25</b> Shuttle L <b>52939-25</b> Shuttle Eco (S) <b>52926-25</b> Shuttle iOn See motor specs on pages 67-68	\$1,061.84 ea. \$853.41 ea. \$860.07 ea. \$1,659.84 ea. 1/box		<b>3100-00</b> Connector Cable For LED Strip	\$25.37 ea. 1/box
				Power Transformer <b>3101-25</b> 40w, 24v <b>3102-25</b> 90w, 24v	\$263.01 ea. \$601.12 ea.

 **BREAK PACK PRICING**  - Prices with this designation indicate a 20% up charge for broken pack quantities.

# MOTORIZATION

SHUTTLE MOTOR SPECIFICATIONS | FMS | RMS | DSXL LED | **RBS** | BCS | DRESDEN | DEVENTER MRS | CORDOBA/GRANADA



Scan for more information on the FOREST RBS Motorized System



## RBS MOTORIZED ROMAN BLIND SYSTEM



- The most durable and functional roman blind system on the market. RBS includes integrated Velcro tape so the fabric can be easily attached and removed.
- Aluminum, white, powder coated extrusion. Best suited for light weight fabrics in contract or residential applications.
- Maximum weight is 10 lbs with a maximum width of 84".
- The Forest tubular motor includes a 10 year warranty. The lithium iOn battery includes a 1 year warranty.



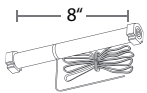
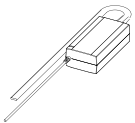

### ASSEMBLED PRICING

Includes headrail, cord roll supports, brackets, counterweight (if requested), Velcro profile, motor and remote or wall switch. When ordering, please specify motor side, wall or ceiling mount, and number of cord roll supports needed. Freight is additional.

RBS Motorized Roman Blind System	first 3 feet	ea. add'l inch
Standard Motor	\$749.68	\$2.67
Lithium iOn Battery Motor	\$761.82	\$2.67

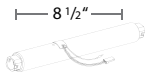
MOTORIZATION RBS

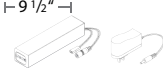
RBS MOT	COMPONENT	PRICE
● 	<b>62903-25</b> RBS Tubular Motor, 24 V Double Shaft Lifts up to 10 lbs.	\$309.60 ea. 1/box
● 	<b>52928-25</b> 7' 6" power cord <b>52934-25</b> 16' power cord Includes 24 v Power Supply	\$135.02 ea. 1/box
● 	<b>52931-25D</b> white <b>59D</b> black +10% Diamond Sense Remote RF, 15 channel w/ holder, Range 98'	\$344.48 ea. 1/box
● 	<b>52933-25</b> white <b>59</b> black +10% Diamond Sense Wall Switch 15 channel	\$169.55 ea. 1/box

RBS MOT	COMPONENT	PRICE
● 	<b>62910-25</b> RBS Tubular Lithium Motor, 1-year warranty 24 V, includes plug	\$408.08 ea. 1/box
● 	<b>62911-25</b> Remote for Lithium Motor 15 channel w/ holder	\$68.05 ea. 1/box
● 	<b>62912-25</b> Lithium Battery & Adaptor	\$244.45 ea. 1/box
● 	<b>52947-25</b> Wireless Connector One-way transmitter to control drapery by third party app or by home automation. Use with Forest Shuttle & tubular motors.	\$213.35 ea. 1/box Includes smart plug

# MOTORIZATION

SHUTTLE MOTOR SPECIFICATIONS | FMS | RMS | DSXL LED | **RBS** | BCS | DRESDEN | DEVENTER MRS | CORDOBA/GRANADA

RBS MOT	COMPONENT	PRICE	RBS MOT	COMPONENT	PRICE
	<b>41019-25</b> RBS Headrail white 19' x 10 rails/bundle bundle = 190'	\$7.29/ft.		<b>43004-25</b> Klick Ceiling Bracket	\$2.47 ea.  \$2.06 ea. / box of 100
	<b>49010-25</b> RBS Cord Roll Support w/ quick lock, 12' drop	\$6.98 ea.  \$6.34 ea. /box of 100		<b>49090-25</b> Valance Bracket attaches to Velcro profile	\$2.84 ea.  \$2.37 ea. /box of 50
	<b>62913-25</b> RBS End Caps left & right	\$1.62/set		<b>49091-25</b> Valance Corners	\$4.13 ea.  \$3.44 ea. /box of 250
	<b>41119-90</b> 19' Rod aluminum 3/16" x 3/16"	\$2.58/ft.  \$2.15/ft. /bundle of 5		<b>49008-00</b> Shade Leveler	\$0.53 ea.  \$0.45 ea. /box of 1000
	<b>49005-25</b> Counterweight, 19' aluminum 1" x 1/8"	\$2.38/ft.  \$1.90/ft. /bundle of 20		<b>39007-25</b> Velcro Tape 27 yds. per roll	\$27.14/roll
	<b>31116-25</b> Velcro Profile w/ Hook Tape, 13.1'	\$4.53/ft.  \$3.78/ft. /bundle of 20		<b>49006-25</b> Fiberglass Spines, 19' 3/16" diameter	\$0.50/ft.  \$0.43/ft. /bundle of 250
	<b>43202-25</b> Swivel Wall Bracket	\$2.19 ea.  \$1.82 ea. /box of 100		<b>49014-25</b> Plastic Snap Ring	\$0.12 ea.  \$0.09 ea. /box of 5000
	<b>43003-25</b> Swivel Ceiling Bracket	\$2.47 ea.  \$2.06 ea. /box of 100		<b>49013-25</b> Plastic Ring Cord Guide	\$0.12 ea.  \$0.09 ea. /box of 5000
	<b>43033-25</b> Klick Wall Bracket	\$2.47 ea.  \$2.06 ea. /box of 200		<b>49400-25</b> Shroud 73 yds. per roll	\$282.00/roll
	<b>43034-25</b> Hidden Klick Multi Bracket	\$2.47 ea.  \$2.06 ea. /box of 100			

 **BREAK PACK PRICING**  - Prices with this designation indicate a 20% up charge for broken pack quantities.

MOTORIZATION RBS

# MOTORIZATION

SHUTTLE MOTOR SPECIFICATIONS | FMS | RMS | DSXL LED | RBS | **BCS** | DRESDEN | DEVENTER MRS | CORDOBA/GRANADA

MOTORIZATION BCS



Scan for more information on the FOREST BCS Blind Contract System

## BCS BLIND CONTRACT SYSTEM

- A heavy duty motorized blind system best suited for medium to heavy weight draperies.
- Aluminum, white, powder coated extrusion.
- Maximum weight is 45 lbs per motor and 8.75 lbs per cord roll. Maximum width is 120".
- Ultra quiet <44dB and easy to install.
- The Forest BCS tubular motor includes a 10 year warranty.











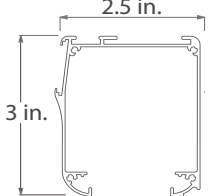











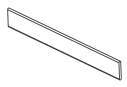

## ASSEMBLED PRICING

Includes headrail, cord roll supports, brackets, counterweight (if requested), Velcro profile, motor and Diamond Sense remote or wall switch. When ordering, please specify motor side, wall or ceiling mount, and number of cord roll supports needed. Freight is additional.

BCS BLIND CONTRACT SYSTEM	first 3 feet	ea. add'l foot
Standard Motor	\$1,201.96	\$83.46

# MOTORIZATION

SHUTTLE MOTOR SPECIFICATIONS | FMS | RMS | DSXL LED | RBS | **BCS** | DRESDEN | DEVENTER MRS | CORDOBA/GRANADA

BCS MOT	COMPONENT	PRICE	BCS MOT	COMPONENT	PRICE
	 <p><b>61019-25</b> BCS Headrail white 19' aluminum extrusion</p>	\$12.07/ft.		 <p><b>49008-00</b> Shade Leveler</p>	\$0.53 ea.  \$0.45 ea. /box of 1000
	 <p><b>61119-25</b> BCS 8-Angle Tube, 19'</p>	\$5.07/ft.		 <p><b>61125-25</b> BCS Velcro 7/8" x 4'</p>	\$15.85/ft.  \$13.21/ft. for bundle of 25
	 <p><b>62309-25</b> BCS End Caps left &amp; right</p>	\$5.92 ea.  \$4.94 ea. /box of 25		 <p><b>49400-25</b> Shroud 73 yds. per roll</p>	\$282.00/roll
	 <p><b>49006-25</b> Fiberglass Rod, 19'</p>	\$0.50/ft.  \$0.43/ft. /bundle of 250		 <p><b>62901-25</b> Forest Tubular Motor built-in RF receiver, 35mm (1 3/8"), 110v, 6 Nm</p>	\$585.58 ea. 1/box
	 <p><b>49005-25</b> BCS Counterweight, 19' aluminum 1" x 1/8"</p>	\$2.38/ft.  \$1.90/ft. /bundle of 20		 <p><b>52931-25D white</b> <b>59D black +10%</b> Diamond Sense Remote RF, 15 channel w/ holder, Range 98'</p>	\$344.48 ea. 1/box
	 <p><b>62000-25</b> BCS Cord Roll House &amp; Drum contains 18' cord</p>	\$59.18 ea.  \$49.32 ea. /box of 25		 <p><b>52933-25 white</b> <b>59 black +10%</b> Diamond Sense Wall Switch 15 channel</p>	\$169.55 ea. 1/box
	 <p><b>62200-25</b> BCS Tube Support place on open end of tube</p>	\$29.90 ea.  \$24.91 ea. /box of 25		 <p><b>52947-25</b> Wireless Connector One-way transmitter to control drapery by third party app or by home automation. Use with Forest Shuttle &amp; tubular motors.</p>	\$213.35 ea. 1/box Includes smart plug
	 <p><b>63001-25</b> BCS Klick Bracket Wall/Ceiling Bracket</p>	\$17.40 ea.  \$14.50 ea. /box of 25			
	 <p><b>62100-25</b> BCS Center Support 2" x 2.25"</p>	\$17.29 ea.  \$14.40 ea. /box of 25			

 **BREAK PACK PRICING**  - Prices with this designation indicate a 20% up charge for broken pack quantities.

MOTORIZATION BCS

# MOTORIZATION

SHUTTLE MOTORS | FMS | RMS | DSXL LED | RBS | BCS | **DRESDEN** | DEVENTER MRS | CORDOBA/GRANADA

MOTORIZATION 1 1/8" DRESDEN



Scan for more information on  
FOREST DRESDEN MOTORIZED

1 1/8" Dresden Motorized System in 22 Polished Chrome



## DRESDEN 1 1/8" MOTORIZED

- 1 1/8" motorized system best suited for light to medium weight draperies.
- Rail can be bent or curved. An actual size template is required. See pages 23-24 for more information. Polished chrome cannot be bent or curved.
- Wall or ceiling mount. See bracket count below.
  - 0-5' = 2 brackets
  - 6-10' = 3 brackets
  - 11-15' = 4 brackets
  - 16-20' = 5 brackets
- Motorize with any Forest Shuttle. See all motor specifications on pages 67-68. All Forest Shuttle motors include a 10 year warranty.
- Control drapes with a gentle tug, wall switch, remote, any home automation system or by smart phone app.

### ASSEMBLED PRICING

Includes rail, motor, power supply, motor pulley, return pulley, single wall brackets, carriers, masters, and Diamond remote or wall switch. Finials are optional and should be ordered separately. See at finial choices on page 31. Freight is additional.

1 1/8" DRESDEN MOTORIZED	first 4 feet	ea. add'l foot
Shuttle HD (M) white	\$2,869.50	\$126.73
Shuttle HD (M) black	\$3,156.44	\$139.41
Shuttle L	\$2,661.06	\$126.73
Shuttle Eco (S)	\$2,813.65	\$126.73
Shuttle iOn	\$3,467.50	\$126.73

See all motor specifications on pages 67-68.

### AVAILABLE FINISHES XX = finish color

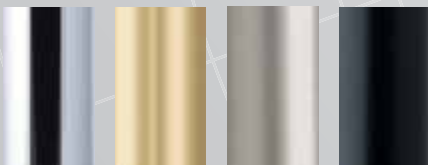

22 Polished Chrome    26 Brushed Gold    29 Satin Nickel    59 Black



# MOTORIZATION

SHUTTLE MOTORS | FMS | RMS | DSXL LED | RBS | BCS | **DRESDEN** | DEVENTER MRS | CORDOBA/GRANADA

MOTORIZATION 1 1/8" DRESDEN

1 1/8" DRESDEN	COMPONENT	PRICE	1 1/8" DRESDEN	COMPONENT	PRICE
	<b>B809-28-XX</b> 1 1/8" Aluminum Rail 19' 7"	\$45.96/ft.		Two Piece Connected Snap Carrier w/ Square Base, in plastic sleeve. Use 1 1/4" snap tape <b>2114-25, 59</b> black 60% fullness, 2 5/8" OC <b>2111-25, 65</b> brown, <b>90</b> silver 80% fullness, 2 3/8" OC <b>2112-25, 59</b> black 100% fullness, 2 1/8" OC <b>2115-25, 59</b> black 120% fullness, 1 7/8" OC	\$1.17 ea.  \$0.97 ea.  /roll of 500  Colors other than white +10%
	<b>B899-4-00</b> Rail Connector	\$38.12 ea.		<b>52008-25</b> Slim Line Klick Carrier Allows drapery to hang and conceal track	\$1.03 ea.  \$0.86 ea.  /box of 250
	<b>B11679-L-XX</b> <b>B11679-R-XX</b> Left/Right Motor Pulley	\$529.61 ea.		<b>52009-25</b> Ball Bearing Carrier	\$1.46 ea.  \$1.20 ea.  /box of 100
	<b>B11683-L-XX</b> <b>B11683-R-XX</b> Left/Right Return Pulley	\$240.73 ea.		<b>52508-25</b> Overlap R <b>52509-25</b> Underlap L Belt Master Carrier	\$12.31 ea.  \$10.27 ea.  /box of 100
	<b>B11682-XX</b> Recess Bracket with Return Pulley	\$224.69 ea.		<b>52508-25A</b> Overlap R <b>52509-25A</b> Underlap L Belt Master Carrier with snaps	\$14.59 ea.  \$12.16 ea.  /box of 100
	<b>B11670-120-XX</b> Single Bracket	\$150.00 ea.		<b>52410-25</b> Butt Right <b>52409-25</b> Butt Left <b>59</b> black +10% Butt Master Carrier with snaps	\$16.96 ea.  \$14.12 ea.  /box of 50
	<b>B11672-220-XX</b> Double Bracket	\$170.12 ea.		<b>2552-25</b> 6" Extension Arm for master Use w/ two one-way draw	\$11.44 ea.  \$9.54 ea.  /box of 50
	<b>B11873-50-XX</b> Ceiling Bracket	\$102.71 ea.			
	<b>B11873-15-XX</b> Ceiling Bracket 5/8" Extension	\$54.57 ea.			
	<b>53408-22, 24, 29, 59</b> Flush Ceiling Bracket Cannot use finials with this bracket	\$20.28 ea.	SEE PAGE 84 FOR MOTOR & CONTROL OPTIONS. FINIALS ARE OPTIONAL. SEE PAGE 32 FOR CHOICES.		

 **BREAK PACK PRICING**  - Prices with this designation indicate a 20% up charge for broken pack quantities.

# MOTORIZATION

SHUTTLE MOTORS | FMS | RMS | DSXL LED | RBS | BCS | **DRESDEN** | DEVENTER MRS | CORDOBA/GRANADA

MOTORIZATION 1 9/16" DRESDEN



Scan for more information on  
FOREST DRESDEN MOTORIZED

1 9/16" Dresden Motorized System in 59 Black



## DRESDEN 1 9/16" MOTORIZED

- 1 9/16" motorized system best suited for light to medium weight draperies.
- Wall or ceiling mount. See bracket count below.
  - 0-5' = 2 brackets
  - 6-10' = 3 brackets
  - 11-15' = 4 brackets
  - 16-20' = 5 brackets
- Motorize with any Forest Shuttle. See all motor specifications on pages 67-68. All Forest Shuttle motors include a 10 year warranty.
- Control drapes with a gentle tug, wall switch, remote, any home automation system or by smart phone app.

### ASSEMBLED PRICING

Includes rail, motor, power supply, motor pulley, return pulley, single wall brackets, carriers, masters, and Diamond remote or wall switch. Double sets are available. Freight is additional.

1 9/16" DRESDEN MOTORIZED	first 4 feet	ea. add'l foot
Shuttle HD (M) white	\$3,215.85	\$152.08
Shuttle HD (M) black	\$3,537.44	\$167.29
Shuttle L	\$3,007.41	\$152.08
Shuttle Eco (S)	\$3,014.08	\$152.08
Shuttle iOn	\$3,813.85	\$152.08

See all motor specifications on pages 67-68.

### AVAILABLE FINISHES XX = finish color



29  
Satin  
Nickel











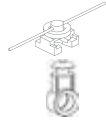
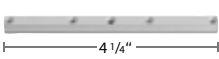



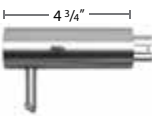
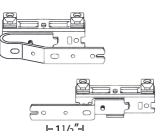

59  
Black

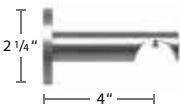
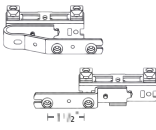
# MOTORIZATION

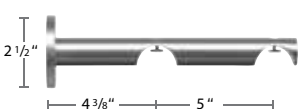
SHUTTLE MOTORS | FMS | RMS | DSXL LED | RBS | BCS | **DRESDEN** | DEVENTER MRS | CORDOBA/GRANADA

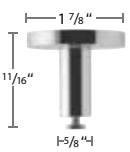
MOTORIZATION 1 9/16" DRESDEN

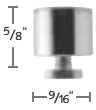
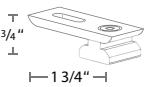
1 9/16" DRESDEN	COMPONENT	PRICE	1 9/16" DRESDEN	COMPONENT	PRICE
	<b>B809-40-XX</b> 1 9/16" Aluminum Rail 19' 7"	\$50.41/ft.		Two Piece Connected Snap Carrier w/ Square Base, in plastic sleeve. Use 1 1/4" snap tape <b>2114-25, 59</b> black 60% fullness, 2 5/8" OC <b>2111-25, 65</b> brown, <b>90</b> silver 80% fullness, 2 3/8" OC <b>2112-25, 59</b> black 100% fullness, 2 1/8" OC <b>2115-25, 59</b> black 120% fullness, 1 7/8" OC	\$1.17 ea.  \$0.97 ea. /roll of 500  Colors other than white +10%
	<b>B899-4-00</b> Rail Connector	\$38.12 ea.		<b>52008-25</b> Slim Line Klick Carrier Allows drapery to hang and conceal track	\$1.03 ea.  \$0.86 ea. /box of 250
	<b>B11679-L-40-XX</b> <b>B11679-R-40-XX</b> Left/Right Motor Pulley	\$557.02 ea.		<b>52009-25</b> Ball Bearing Carrier	\$1.46 ea.  \$1.20 ea. /box of 100
	<b>B11683-L-40-XX</b> <b>B11683-R-40-XX</b> Left/Right Return Pulley	\$258.41 ea.		<b>52508-25</b> Overlap R <b>52509-25</b> Underlap L Belt Master Carrier	\$12.31 ea.  \$10.27 ea. /box of 100
	<b>B40970-XX</b> Single Bracket	\$152.06 ea.		<b>52508-25A</b> Overlap R <b>52509-25A</b> Underlap L Belt Master Carrier with snaps	\$14.59 ea.  \$12.16 ea. /box of 100
	<b>B40872-235-XX</b> Double Bracket	\$162.28 ea.		<b>52410-25</b> Butt Right <b>52409-25</b> Butt Left <b>59</b> black +10% Butt Master Carrier with snaps	\$16.96 ea.  \$14.12 ea. /box of 50
	<b>B11873-50-XX</b> Ceiling Bracket	\$102.71 ea.		<b>2552-25</b> 6" Extension Arm for master Use w/ two one-way draw	\$11.44 ea.  \$9.54 ea. /box of 50
	<b>B11873-15-XX</b> Ceiling Bracket 5/8" Extension	\$54.57 ea.	SEE PAGE 84 FOR MOTOR & CONTROL OPTIONS.		
	<b>53408-22, 24, 29, 59</b> Flush Ceiling Bracket Cannot use finials with this bracket	\$20.28 ea.			

 **BREAK PACK PRICING**  - Prices with this designation indicate a 20% up charge for broken pack quantities.

# DRESDEN 1 1/8" & 1 9/16" MOTORIZED

## WEAR RESISTANT PULLEY HOUSING

For low wear operation the pulley housing has been equipped with high quality ball bearings.



## REINFORCED BELT



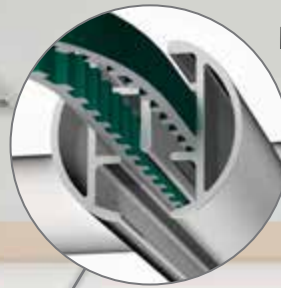



The Kevlar reinforced belt runs quietly and has superior longevity.



## FOREST SHUTTLE MOTORS

- Touch Impulse Technology opens or closes drapes with a gentle tug.
- Integrated emergency control insures manual operation of the drapery in case of power failure.
  - Choose the Forest Shuttle Eco for lightweight fabrics.
  - Choose the Forest Shuttle HD for strength and an economical price.
- All Forest Shuttle drapery motors come with a 10-year warranty.



DRESDEN	COMPONENT	PRICE
● 	<b>52925-25</b> Shuttle HD (M) white <b>52925-59</b> Shuttle HD (M) black <b>52923-25</b> Shuttle L <b>52939-25</b> Shuttle Eco (S) <b>52926-25</b> Shuttle iOn See motor specs on pages 67-68	\$1,061.84 ea. \$1,168.04 ea. \$853.41 ea. \$860.07 ea. \$1,659.84 ea. 1/box
● 	<b>52928-25</b> 7' 6" power cord <b>52934-25</b> 16' power cord Includes 24 v Power Supply	\$135.02 ea. 1/box
● 	<b>9012-25</b> Transport Belt Kevlar reinforced	\$11.12/ft.  \$9.25/ft. /roll of 328 ft.
● 	<b>52512-25</b> white <b>59</b> black +10% Transport Belt Connector	\$11.51 ea.  \$9.62 ea. /box of 50

DRESDEN	COMPONENT	PRICE
● 	<b>52931-25D</b> white <b>59D</b> black +10% Diamond Sense Remote RF, 15 channel w/ holder, Range 98'	\$344.48 ea. 1/box
● 	<b>52933-25</b> white <b>59</b> black +10% Diamond Sense Wall Switch 15 channel	\$169.55 ea. 1/box
● 	<b>52947-25</b> Wireless Connector One-way transmitter to control drapery by third party app or by home automation. Use with Forest Shuttle & tubular motors.	\$213.35 ea. 1/box Includes smart plug
●  	<b>52948-25</b> <b>59</b> black +10% Wi-Fi Dongle Bi-directional communication using Forest Connect app. Use with Forest Shuttle motors.	\$210.53 ea. 1/box

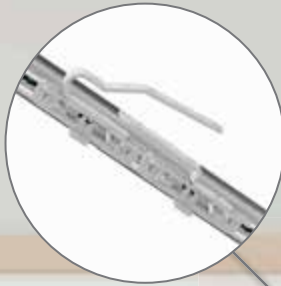

**COMPLETELY CLOSED DRAPERIES USING OVERLAP MASTERS**

The overlap master carrier guarantees a complete 3" overlap of the draperies. Extended arms available.



**RETURN PULLEY**

The return pulley is made of a special plastic and uses a bearing which allows ultra-smooth operation.



**SELECT YOUR INDIVIDUAL FINIAL**

Our decorative finials offer a variety of design options. See page 30 for finial options for 1 1/8" only.

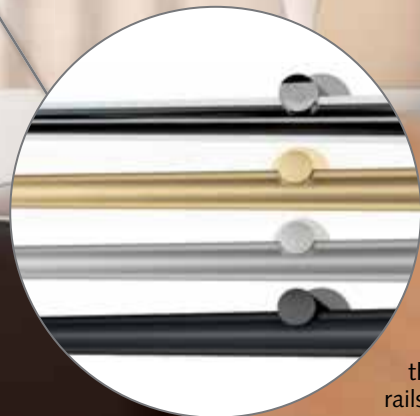

**HIGH-GRADE ALUMINUM:**

1 1/8" rails are available in the finishes below. 1 9/16" rails are available in -29 Satin Nickel and -59 Black only.

- Polished Chrome - 22
- Brushed Gold - 26
- Satin Nickel - 29
- Black - 59



# MOTORIZATION

SHUTTLE MOTORS | FMS | RMS | DSXL LED | RBS | BCS | DRESDEN | **DEVENTER MRS** | CORDOBA/GRANADA

MOTORIZATION DEVENTER MRS



Scan for more information on  
FOREST DEVENTER MRS MOTORIZED

## DEVENTER MRS® MOTORIZED

- 1 1/8" motorized system best suited for light to medium weight draperies.
- Wall or ceiling mount. See bracket count below.

0-5'	=	2 brackets
6-10'	=	3 brackets
11-15'	=	4 brackets
16-20'	=	5 brackets

- Motorize with any Forest Shuttle. See all motor specifications on pages 67-68. All Forest Shuttle motors include a 10 year warranty.
- Control drapes with a gentle tug, wall switch, remote, any home automation system or by smart phone app.



81 Antique Bronze Deventer MRS Rail with finished end pulley.

### ASSEMBLED PRICING

Includes rail, motor, power supply, motor pulley, return pulley, wall or ceiling brackets, carriers, masters, and Diamond remote or wall switch. Double sets are available. Freight is additional.

DEVENTER MRS MOTORIZED	first 4 feet	ea. add'l foot
Shuttle HD (M) white	\$2,674.82	\$81.95
Shuttle HD (M) black	\$2,942.30	\$90.15
Shuttle L	\$2,466.38	\$81.95
Shuttle Eco (S)	\$2,620.56	\$81.95
Shuttle iOn	\$3,272.82	\$81.95

See all motor specifications on pages 67-68.

### AVAILABLE FINISHES XX = finish color

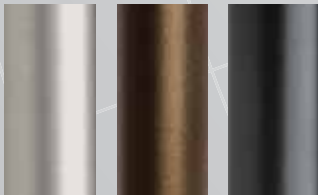

29  
Satin  
Nickel

81  
Antique  
Bronze











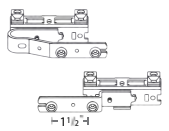
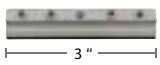

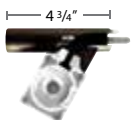

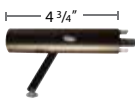

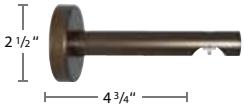

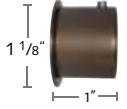
89  
Graphite

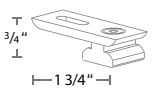
FINIALS ARE OPTIONAL. SEE PAGE 46 FOR CHOICES.

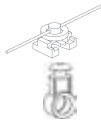
# MOTORIZATION

SHUTTLE MOTORS | FMS | RMS | DSXL LED | RBS | BCS | DRESDEN | **DEVENTER MRS** | CORDOBA/GRANADA

MOTORIZATION DEVENTER MRS

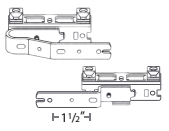
DEV MOT	COMPONENT	PRICE	DEV MOT	COMPONENT	PRICE
	<b>51919-XX</b> 1 1/8" Aluminum Rail 19' 7"	\$44.59/ft.		<b>52508-25A</b> Overlap R <b>52509-25A</b> Underlap L 59 black, 65 brown, 90 silver +10% Belt Master Carrier with snaps	\$14.59 ea. \$12.16 ea. /box of 100
	<b>53413-90</b> Rail Connector aluminum, 3"	\$18.85 ea. 25/box		<b>52410-25</b> Butt Right <b>52409-25</b> Butt Left 59 black, 65 brown, 90 silver +10% Butt Master with snaps	\$16.96 ea. \$14.12 ea. /box of 50
	<b>51901-XX</b> Left Motor Pulley <b>51902-XX</b> Right Motor Pulley	\$367.81 ea.		<b>52925-25</b> Shuttle HD (M) white <b>52925-59</b> Shuttle HD (M) black <b>52923-25</b> Shuttle L <b>52939-25</b> Shuttle Eco (S) <b>52926-25</b> Shuttle iOn See motor specs on pages 67-68	\$1,061.84 ea. \$1,168.04 ea. \$853.41 ea. \$860.07 ea. \$1,659.84 ea. 1/box
	<b>51903-XX</b> Left Return Pulley <b>51904-XX</b> Right Return Pulley	\$158.77 ea.		<b>52928-25</b> 7' 6" power cord <b>52934-25</b> 16' power cord Includes 24 v Power Supply	\$135.02 ea. 1/box
	<b>53402-XX</b> Extended Single Bracket	\$73.17 ea. 2/box		<b>9012-25</b> Transport Belt Kevlar reinforced	\$11.12/ft. \$9.25/ft. /roll of 328 ft.
	<b>53412-XX</b> Inside Mount Bracket	\$87.89 ea.		<b>52512-25</b> white 59 black +10% Transport Belt Connector	\$11.51 ea. \$9.62 ea. /box of 50
	<b>53408-XX</b> 25 white, 29 satin nickel, 59 black, 81 bronze Flush Ceiling Bracket Cannot use finials	\$20.28 ea.		<b>52931-25D</b> white 59D black +10% Diamond Sense Remote RF, 15 channel w/ holder, Range 98'	\$344.48 ea. 1/box
	Two Piece Connected Snap Carrier w/ Square Base, in plastic sleeve. Use 1 1/4" snap tape <b>2114-25, 59</b> black 60% fullness, 2 5/8" OC <b>2111-25, 65</b> brown, <b>90</b> silver 80% fullness, 2 3/8" OC <b>2112-25, 59</b> black 100% fullness, 2 1/8" OC <b>2115-25, 59</b> black 120% fullness, 1 7/8" OC	\$1.17 ea. \$0.97 ea. /roll of 500  Colors other than white +10%		<b>52933-25</b> white 59D black +10% Diamond Sense Wall Switch 15 channel	\$169.55 ea. 1/box
	<b>52008-25</b> 59 black, 65 brown +10% Slim Line Klick Carrier Allows drapery to hang and conceal track	\$1.03 ea. \$0.86 ea. /box of 250		<b>52947-25</b> Wireless Connector One-way transmitter to control drapery by third party app or by home automation. Use with Forest Shuttle & tubular motors.	\$213.35 ea. 1/box Includes smart plug
	<b>52009-25</b> Ball Bearing Carrier	\$1.46 ea. \$1.20 ea. /box of 100		<b>52948-25</b> 59 black +10% Wi-Fi Dongle Bi-directional communication using Forest Connect app. Use with Forest Shuttle motors.	\$210.53 ea. 1/box
	<b>52508-25</b> Overlap R <b>52509-25</b> Underlap L 59 black, 65 brown, 90 silver +10% Belt Master Carrier	\$12.31 ea. \$10.27 ea. /box of 100			

**BREAK PACK PRICING** - Prices with this designation indicate a 20% up charge for broken pack quantities.

# MOTORIZATION

SHUTTLE MOTORS | FMS | RMS | DSXL LED | RBS | BCS | DRESDEN | DEVENTER MRS | **CORDOBA & GRANADA WOOD**

MOTORIZATION WOOD



Scan for more information on FOREST MOTORIZED WOOD

## 2" CORDOBA & 2 3/4" GRANADA MOTORIZED

- Forest FMS Track with wood pole fascia in 2" or 2 3/4" diameters.
- Motorize with any Forest Shuttle. See all motor specifications on pages 67-68. All Forest Shuttle motors include a 10 year warranty.
- Control drapes with a gentle tug, wall switch, remote, any home automation system or by smart phone app.



2" Cordoba reeded fascia in 72 Walnut with Odesia finial.

### ASSEMBLED PRICING

Includes assembled track, wood fascia, motor, power supply, single wall brackets, and Diamond remote or wall switch. Freight is additional.

WOOD MOTORIZED	HD (M) white	Eco (S)	L	iOn	All
	first 4 feet	first 4 feet	first 4 feet	first 4 feet	ea. add'l ft.
2" Single Unfinished	\$1,950.74	\$1,786.20	\$1,742.31	\$2,385.24	\$54.07
2" Single Finished	\$2,006.71	\$1,842.18	\$1,798.27	\$2,441.22	\$65.81
2" Double Unfinished	\$3,698.06	\$3,533.52	\$3,489.63	\$4,132.56	\$96.38
2" Double Finished	\$3,762.36	\$3,597.82	\$3,553.92	\$4,196.86	\$102.25
2 3/4" Single Unfinished	\$2,006.59	\$1,842.05	\$1,798.15	\$2,441.09	\$68.17
2 3/4" Double Unfinished	\$3,877.78	\$3,713.25	\$3,669.34	\$4,312.29	\$113.99

See all motor specifications on pages 67-68.

### AVAILABLE FINISHES XX = finish color



- 00  
Unfinished
- 25  
White
- 37  
Sand Gold  
Antiqued  
smooth  
poles only
- 45  
Leather  
Antiqued  
smooth  
poles only
- 58  
Stone  
smooth  
poles only
- 59  
Black
- 70  
Hazel
- 71  
Honey
- 72  
Walnut
- 73  
Natural



# MOTORIZATION

SHUTTLE MOTORS | FMS | RMS | DSXL LED | RBS | BCS | DRESDEN | DEVENTER MRS | **CORDOBA & GRANADA WOOD**

WOOD	COMPONENT	PRICE	WOOD	COMPONENT	PRICE
	<b>51323-25</b> white <b>59</b> black +10% FMS Track 23' x 10 tracks per bundle bundle = 230'	\$5.55/ft.		<b>52508-25A</b> Overlap Right <b>52509-25A</b> Underlap Left <b>59A</b> black +10% Belt Master Carrier with snaps	\$14.59 ea.  \$12.16 ea. /box of 100
	<b>1051RSW-XX</b> 2" Cordoba Smooth, 14' <b>1072RSW-00</b> 2 3/4" Granada Smooth, 13'	See pricing pages 60 & 62		<b>52410-25</b> Butt Right <b>52409-25</b> Butt Left <b>59</b> black +10% Butt Master Carrier with snaps	\$16.96 ea.  \$14.12 ea. /box of 50
	<b>1051RRW-XX</b> 2" Cordoba Reeded, 14' <b>1072RSW-00</b> 2 3/4" Granada Reeded, 13'	See pricing pages 60 & 62		<b>2552-25</b> 6" Extension Arm for master Use w/ two one-way draw	\$11.44 ea.  \$9.54 ea. /box of 50
	<b>1151WEN-XX</b> 2" Cordoba End Cap <b>1172WEN-XX</b> 2 3/4" Granada End Cap See all finials pages 60 & 62	See pricing pages 60 & 62		<b>52925-25</b> Shuttle HD (M) white <b>52925-59</b> Shuttle HD (M) black <b>52923-25</b> Shuttle L <b>52939-25</b> Shuttle Eco (S) <b>52926-25</b> Shuttle iOn See motor specs on pages 67-68	\$1,061.84 ea. \$1,168.04 ea. \$853.41 ea. \$860.07 ea. \$1,659.84 ea. 1/box
	<b>3906-25</b> <b>59</b> black +10% Track Connector & key 3904-00	\$16.16 ea.		<b>52928-25</b> 7' 6" power cord <b>52934-25</b> 16' power cord Includes 24 v Power Supply	\$135.02 ea. 1/box
	<b>3280-25</b> <b>59</b> black +10% 3" Single Wall Bracket heavy duty projection 2 1/2"	\$11.57 ea.  \$9.64 ea. /box of 20		<b>9012-25</b> Transport Belt Kevlar reinforced	\$11.12/ft.  \$9.25/ft. /roll of 328 ft.
	<b>3281-25</b> <b>59</b> black +10% 6" Double Wall Bracket heavy duty projection 1 1/2", 5 1/2"	\$16.58 ea.  \$13.82 ea. /box of 15		<b>52512-25</b> white <b>59</b> black +10% Transport Belt Connector	\$11.51 ea.  \$9.62 ea. /box of 50
	<b>32801-25</b> <b>59</b> black +10% Wall Bracket Cover use with 3280 & 3281	\$2.98 ea.  \$2.49 ea. /box of 50		<b>52903-25</b> <b>59</b> black +10% Motor Pulley Connects motor to track	\$90.93 ea. 1/box
	<b>2114-25</b> 60% fullness 2 5/8" OC <b>2111-25</b> 80% fullness 2 3/8" OC <b>2112-25</b> 100% fullness 2 1/8" OC <b>2115-25</b> 120% fullness 1 7/8" OC <b>59</b> black (all but 80%), <b>65</b> brown, <b>90</b> silver (80% only) Two-Piece Connected Snap Carrier w/ Square Base, use 4 1/4" snap tape.	\$1.17 ea.  \$0.97 ea. /roll of 500  Colors other than white +10%		<b>52931-25D</b> white <b>59D</b> black +10% Diamond Sense Remote RF, 15 channel w/ holder, Range 98'	\$344.48 ea. 1/box
	<b>52008-25</b> <b>59</b> black +10% Slim Line Klick Carrier Draperies hang to conceal track	\$1.03 ea.  \$0.86 ea. /box of 250		<b>52933-25</b> white <b>59</b> black +10% Diamond Sense Wall Switch 15 channel	\$169.55 ea. 1/box
	<b>52009-25</b> Ball Bearing Carrier for motorization	\$1.46 ea.  \$1.20 ea. /box of 250		<b>52947-25</b> Wireless Connector One-way transmitter to control drapery by third party app or home automation. Works with all Forest Shuttle & tubular motors.	\$213.35 ea. 1/box Includes smart plug
	<b>52508-25</b> Overlap Right <b>52509-25</b> Underlap Left <b>59</b> black +10% Belt Master Carrier	\$12.31 ea.  \$10.27 ea. /box of 100		<b>52948-25</b> <b>59</b> black +10% Wi-Fi Dongle Bi-directional communication us- ing Forest Connect app. Use with Forest Shuttle motors.	\$210.53 ea. 1/box

 **BREAK PACK PRICING**  - Prices with this designation indicate a 20% up charge for broken pack quantities.

MOTORIZATION WOOD



# FOREST ROLLER SHADE SYSTEMS

Chain draw or motorized and basic to decorative

## APOLLO BASIC ROLLER SHADES

Cassette and Direct

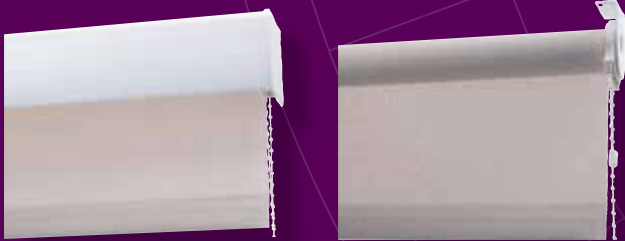

## MERCURY DECORATIVE ROLLER SHADES

Fascia Double, Semi Open, and Direct



**MOTOR**  
CONTROL  
AVAILABLE



Forest Roller Shades are high quality for residential or commercial use. All roller shade styles can be fabricated with one of our in stock fabrics, or a fabric from our special order binder.

## **ATLANTIS** HEAVY DUTY MOTORIZED ROLLER SHADES



**FABRIC** FOR ROLLER SHADES IN 3 COLLECTIONS  
Essentials, Designer and Exclusives

# ROLLER SHADES

APOLLO BASIC | MERCURY DECORATIVE | ATLANTIS HEAVY DUTY | FABRIC OPTIONS



Scan for more information on FOREST Apollo Basic Roller Shades

## APOLLO CASSETTE & DIRECT MOUNT

- Wall or ceiling mount for residential or contract use
- Maximum weight is 8 lbs. 13 oz.
- 1 1/2" / 38mm tube and a bi-directional clutch

### CASSETTE MOUNT ASSEMBLED PRICING

Includes Essentials fabric (see pages 105-106 for all fabric options), 38mm tube, roller mechanisms, brackets, bracket covers, valance, bottom rail with end caps, and child safety device. Designer fabrics +20%. Exclusive fabrics +40%. Side channels are additional. Freight is additional.

	WIDTH							
	24"	36"	48"	60"	72"	84"	96"	108"
24"	\$238.13	\$259.33	\$280.54	\$301.74	\$322.95	\$344.16	\$365.36	\$386.57
36"	\$290.07	\$311.27	\$332.48	\$353.68	\$374.89	\$396.09	\$417.30	\$438.50
48"	\$342.00	\$363.21	\$384.41	\$405.62	\$426.83	\$448.03	\$469.24	\$490.44
60"	\$393.94	\$415.15	\$436.35	\$457.56	\$478.76	\$499.97	\$521.17	
72"	\$445.88	\$467.08	\$488.29	\$509.50	\$530.70	\$551.91	\$573.11	
84"	\$497.82	\$519.02	\$540.23	\$561.43	\$582.64			
96"	\$549.75	\$570.96	\$592.16	\$613.37				
108"	\$601.69	\$622.90	\$644.10					



25 White

### DIRECT MOUNT ASSEMBLED PRICING

Includes Essentials fabric (see pages 105-106 for all fabric options), 38mm tube, roller mechanisms, brackets, bracket covers, bottom rail with end caps, and child safety device. Designer fabrics +20%. Exclusive fabrics +40%. Side channels are additional. Freight is additional.









	WIDTH							
	24"	36"	48"	60"	72"	84"	96"	108"
24"	\$194.53	\$204.38	\$214.23	\$224.08	\$233.92	\$243.77	\$253.62	\$263.47
36"	\$246.47	\$256.32	\$266.16	\$276.01	\$285.86	\$295.71	\$305.56	\$315.41
48"	\$298.40	\$308.25	\$318.10	\$327.95	\$337.80	\$347.65	\$357.50	\$367.35
60"	\$350.34	\$360.19	\$370.04	\$379.89	\$389.74	\$399.59	\$409.43	
72"	\$402.28	\$412.13	\$421.98	\$431.83	\$441.67	\$451.52	\$461.37	
84"	\$454.22	\$464.07	\$473.91	\$483.76	\$493.61			
96"	\$506.15	\$516.00	\$525.85	\$535.70				
108"	\$558.09	\$567.94	\$577.79					





25 White

# ROLLER SHADES

APOLLO BASIC | MERCURY DECORATIVE | ATLANTIS HEAVY DUTY | FABRIC OPTIONS

CASSETTE	DIRECT	COMPONENT	PRICE	CASSETTE	DIRECT	COMPONENT	PRICE
●	●	 <b>71119-90</b> 1 1/2" / 38mm 19' Tube, aluminum	\$4.64/ft.	●	●	 Endless Chain 25 white plastic or 90 nickel <b>49020-25, 90, 29"</b> \$2.14 ea. <b>49021-25, 90, 39"</b> \$2.48 ea. <b>49022-25, 90, 49"</b> \$3.07 ea. <b>49023-25, 90, 59"</b> \$3.41 ea. <b>49024-25, 90, 69"</b> \$3.59 ea. <b>49025-25, 90, 79"</b> \$3.70 ea. <b>49026-25, 90, 89"</b> \$3.83 ea. <b>49027-25, 90, 99"</b> \$4.15 ea.	
●	●	 <b>72311-25</b> Hold Down Strip with adhesive for tube 2,000 ft/roll	\$0.51/ft.	●	●	 <b>79005-00</b> Clear Ball Stopper	\$1.07 ea.  \$0.89 ea./box 500
●	●	 <b>72309HD-25</b> Heavy Duty Clutch w/ end plug	\$12.01/set 1 set/box	●	●	 <b>49501-00</b> Tension Device For child safety	\$8.19 ea.  \$6.81 ea./box 250
●	●	 <b>72306-25</b> Multi-Purpose Bracket steel, 2 pcs	\$4.21/set 1 set/box	●	●	 <b>810219-25</b> Bottom Rail	\$4.78/ft.
●	●	 <b>72304-25</b> Bracket Cover	\$2.05/set 1 set/box	●	●	 <b>810001-25</b> Weight Insert for bottom rail	\$7.29/ft.
●	●	 <b>72307-90</b> Wall Bracket steel	\$9.86 ea.	●	●	 <b>810019-25</b> Adhesive Tape for bottom rail	\$2.28/ft.
●	●	 <b>72308-90</b> Ceiling Bracket steel	\$3.85 ea.	●	●	 <b>830004-25</b> End Cap for bottom rail	\$1.11 ea.
●	●	 <b>71312-25</b> Cassette Headrail, 13'	\$5.60/ft.	●	●	 <b>810000-00</b> Brush for bottom rail	\$1.98/ft.
●	●	 <b>79001-25</b> Screw, 2 needed per headrail	\$0.11 ea.	●	●	 2 Piece Outside Mount Side Channel <b>71619-25</b> Bottom \$6.58/ft. <b>71719-25</b> Top \$5.65/ft.	
●	●	 <b>72314-25</b> Cassette Bracket Covers	\$8.41/set	●	●	 <b>810119-25</b> One Piece Inside Mount Side Channel, 19'	\$12.96/ft.
●	●	 <b>79001-25</b> Screw, 6 needed per set of 2 bracket covers	\$0.11 ea.	●	●	 <b>79002-25</b> Brush for side channel	\$0.68/ft.
●	●	 <b>71412-25</b> Cassette Valance, 13' aluminum, white	\$3.56/ft.				

 **BREAK PACK PRICING**  - Prices with this designation indicate a 20% up charge for broken pack quantities.

SEE PAGES 105-106 FOR FABRIC OPTIONS.

ROLLER SHADES APOLLO BASIC

# ROLLER SHADES

APOLLO BASIC | **MERCURY DECORATIVE** | ATLANTIS HEAVY DUTY | FABRIC OPTIONS



Scan for more information on FOREST Mercury Double Fascia Roller Shades

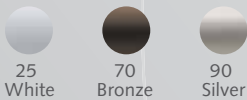

## MERCURY DOUBLE FASCIA

- Ideal for double treatment
- Complete blackout possible with side channels
- Heavy duty with quick and easy installation
- 38mm, 42mm and 50mm tube options and a bi-directional clutch



**MOTOR CONTROL AVAILABLE**

### CHAIN DRAW ASSEMBLED PRICING

Includes Essentials fabric (see pages 105-106 for all fabric options), 38mm tube, roller mechanisms, brackets, bracket covers, counterweights or bottom rails with end caps, and child safety device. Designer fabrics +20%. Exclusive fabrics +40%. Side channels are additional. Add 10% for 42mm and 15% for 50mm. Freight is additional.

LENGTH	WIDTH							
	24"	36"	48"	60"	72"	84"	96"	108"
24"	\$447.43	\$479.66	\$511.89	\$544.12	\$576.35	\$608.58	\$640.81	\$673.04
36"	\$629.72	\$661.95	\$694.18	\$726.41	\$758.64	\$790.87	\$823.10	\$855.33
48"	\$812.01	\$844.24	\$876.47	\$908.70	\$940.93	\$973.16	\$1,005.39	\$1,037.62
60"	\$994.31	\$1,026.53	\$1,058.76	\$1,090.99	\$1,123.22	\$1,155.45	\$1,187.68	
72"	\$1,176.60	\$1,208.83	\$1,241.06	\$1,273.29	\$1,305.51	\$1,337.74		
84"	\$1,358.89	\$1,391.12	\$1,423.35	\$1,455.58	\$1,487.81			
96"	\$1,541.18	\$1,573.41	\$1,605.64	\$1,637.87				
108"	\$1,723.47	\$1,755.70	\$1,787.93					











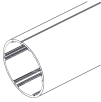



### MOTORIZED ASSEMBLED PRICING

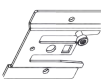
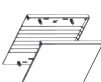

Includes Essentials fabric (see pages 105-106 for all fabric options), two 38mm tube, motor, micro usb cable to charge battery, brackets, bracket covers, counterweight or bottom rail with end caps and remote. Designer fabrics +20%. Exclusive fabrics +40%. Side channels are additional. Add 10% for 42mm and 15% for 50mm. Freight is additional.



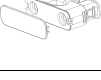











LENGTH	WIDTH							
	24"	36"	48"	60"	72"	84"	96"	108"
24"	\$1,544.69	\$1,576.95	\$1,609.21	\$1,641.47	\$1,673.73	\$1,706.00	\$1,738.26	\$1,770.52
36"	\$1,640.76	\$1,673.02	\$1,705.28	\$1,737.54	\$1,769.80	\$1,802.06	\$1,834.32	\$1,866.58
48"	\$1,736.82	\$1,769.08	\$1,801.34	\$1,833.60	\$1,865.86	\$1,898.13	\$1,930.39	\$1,962.65
60"	\$1,832.89	\$1,865.15	\$1,897.41	\$1,929.67	\$1,961.93	\$1,994.19	\$2,026.45	
72"	\$1,928.95	\$1,961.21	\$1,993.47	\$2,025.73	\$2,057.99	\$2,090.25		
84"	\$2,025.02	\$2,057.28	\$2,089.54	\$2,121.80	\$2,154.06			
96"	\$2,121.08	\$2,153.34	\$2,185.60	\$2,217.86				
108"	\$2,217.15	\$2,249.41	\$2,281.67					

# ROLLER SHADES

APOLLO BASIC | **MERCURY DECORATIVE** | ATLANTIS HEAVY DUTY | FABRIC OPTIONS

FASCIA	COMPONENT	PRICE
●	 Aluminum Tube, 19' 77003-90 38mm \$4.82/ft. 77002-90 42mm \$9.33/ft. 77001-90 50mm \$13.08/ft.	
●	 76013-XX Clutch Mechanism Plastic, 38mm \$20.39 ea.	
●	 Tube Adaptor 76003-25 42mm, 50mm \$1.54 ea.	
●	 Easy Mount End Plug 76005-XX 38mm \$2.41 ea. 76004-XX 42mm, 50mm \$3.06 ea.	
●	 77010-XX Fascia Front, 19' \$17.98/ft.	
●	 76050-XX Fascia Box Bracket \$27.00 ea.	
●	 76051-90 Box Bracket Attachment Adaptor \$4.99/set	
●	 76052-XX Box Bracket End Caps \$9.63/set	
●	 Endless Chain 25 white plastic or 90 nickel 49020-25, 90, 29" \$2.14 ea. 49021-25, 90, 39" \$2.48 ea. 49022-25, 90, 49" \$3.07 ea. 49023-25, 90, 59" \$3.41 ea. 49024-25, 90, 69" \$3.59 ea. 49025-25, 90, 79" \$3.70 ea. 49026-25, 90, 89" \$3.83 ea. 49027-25, 90, 99" \$4.15 ea.	
●	 49501-00 Tension Device For child safety \$8.19 ea.  \$6.81 ea./box 250	
●	 79005-00 Clear Ball Stopper \$1.07 ea.  \$0.89 ea./box 500	
●	 76053-25 Chain Guide Adaptor, Long \$2.52 ea.	
●	 76054-25 Chain Guide Adaptor Medium \$4.67 ea.	

 **BREAK PACK PRICING**  - Prices with this designation indicate a 20% up charge for broken pack quantities.

FASCIA	COMPONENT	PRICE
●	 76002-XX Fill up Ring \$1.35 ea.	
●	 76001-XX Bearing Pin \$1.96 ea.	
●	 810219-25 Bottom Rail \$4.78/ft.	
●	 810001-25 Weight Insert for bottom rail \$7.29/ft.	
●	 810019-25 Adhesive Tape for bottom rail \$2.28/yd.	
●	 830004-25 End Cap for bottom rail \$1.11 ea.	
●	 810000-00 Brush for bottom rail \$1.98/ft.	
●	 2 Piece Outside Mount Side Channel 71619-25 Bottom \$6.58/ft. 71719-25 Top \$5.65/ft.	
●	 810119-25 One Piece Inside Mount Side Channel, 19' \$12.96/ft.	
●	 79002-25 Brush for side channel \$0.68/ft.	
●	 78000-25 Motor & lithium battery \$481.18 ea.	
●	 Drive for Mercury Motor 78001-25 38mm \$16.41 ea. 78020-25 40mm, 50mm \$16.40 ea.	
●	 Crown Adaptor for Mercury Motor 78002-25 38mm \$4.96 ea. 78010-25 40mm, 50mm \$4.79 ea.	
●	 78003-25 Micro USB Cable for motor for Mercury Motor, 9.8 ft. \$20.95 ea.	
●	 78004-59 Remote for Mercury Motor, 5 channel, black \$103.64 ea.	

SEE PAGE 105-106 FOR FABRIC OPTIONS.

# ROLLER SHADES

APOLLO BASIC | **MERCURY DECORATIVE** | ATLANTIS HEAVY DUTY | FABRIC OPTIONS

ROLLER SHADES MERCURY DECORATIVE



Scan for more information on FOREST Mercury Semi Open Roller Shades



25 White



59 Black



70 Bronze



90 Silver

## MERCURY SEMI OPEN MOUNT

- Luxury installation cassette
- As a double, closes perfectly when blind is pulled down
- Almost no light gap on the top due to installation clip
- 38mm, 42mm and 50mm tube options and a bi-directional clutch



**MOTOR CONTROL AVAILABLE**

### CHAIN DRAW ASSEMBLED PRICING

Includes Essetials fabric (see pages 105-106 for all fabric options), 38mm tubes, roller mechanisms, brackets, bracket covers, and counterweight or bottom rail with end caps. Designer fabrics +20%. Exclusive fabrics +40%. Side channels are additional. Add 10% for 42mm and 15% for 50mm. Freight is additional.

	WIDTH							
	24"	36"	48"	60"	72"	84"	96"	108"
24"	\$255.46	\$283.13	\$310.79	\$338.46	\$366.12	\$393.78	\$421.45	\$449.11
36"	\$307.88	\$335.54	\$363.21	\$390.87	\$418.54	\$446.20	\$473.86	\$501.53
48"	\$351.87	\$379.54	\$407.20	\$434.86	\$462.53	\$490.19	\$517.86	\$545.52
60"	\$395.86	\$423.53	\$451.19	\$478.86	\$506.52	\$534.18	\$561.85	
72"	\$439.86	\$467.52	\$495.18	\$522.85	\$550.51	\$578.18		
84"	\$483.85	\$511.51	\$539.18	\$566.84	\$594.50			
96"	\$527.84	\$555.50	\$583.17	\$610.83				
108"	\$571.83	\$599.50	\$627.16					

### MOTORIZED ASSEMBLED PRICING















Includes Essetials fabric (see pages 105-106 for all fabric options), 38mm tube, motor, micro usb cable to charge battery, brackets, bracket covers, bottom rail with end caps and remote. Designer fabrics +20%. Exclusive fabrics +40%. Side channels are additional. Add 10% for 42mm and 15% for 50mm. Freight is additional.



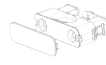





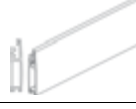

	WIDTH							
	24"	36"	48"	60"	72"	84"	96"	108"
24"	\$894.54	\$926.60	\$958.67	\$990.73	\$1,022.79	\$1,054.86	\$1,086.92	\$1,118.98
36"	\$946.47	\$978.53	\$1,010.59	\$1,042.66	\$1,074.72	\$1,106.78	\$1,138.85	\$1,170.91
48"	\$998.39	\$1,030.46	\$1,062.52	\$1,094.58	\$1,126.65	\$1,158.71	\$1,190.77	\$1,222.84
60"	\$1,050.32	\$1,082.38	\$1,114.45	\$1,146.51	\$1,178.57	\$1,210.64	\$1,242.70	
72"	\$1,102.25	\$1,134.31	\$1,166.38	\$1,198.44	\$1,230.50	\$1,262.56		
84"	\$1,154.18	\$1,186.24	\$1,218.30	\$1,250.37	\$1,282.43			
96"	\$1,206.10	\$1,238.17	\$1,270.23	\$1,302.29				
108"	\$1,258.03	\$1,290.09	\$1,322.16					



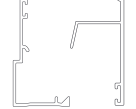
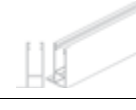

# ROLLER SHADES

APOLLO BASIC | **MERCURY DECORATIVE** | ATLANTIS HEAVY DUTY | FABRIC OPTIONS

SEMI OPEN	COMPONENT	PRICE
●	 Aluminum Tube, 19' <b>77003-90</b> 38mm \$4.82/ft. <b>77002-90</b> 42mm \$9.33/ft. <b>77001-90</b> 50mm \$13.08/ft.	
●	 <b>76013-XX</b> Clutch Mechanism Plastic, 38mm \$20.39 ea.	
●	 Tube Adaptor <b>76003-25</b> 42mm, 50mm \$1.54 ea.	
●	 Easy Mount End Plug <b>76005-XX</b> 38mm \$2.41 ea. <b>76004-XX</b> 42mm, 50mm \$3.06 ea.	
●	 <b>76019-XX</b> Semi Open Bracket for Cassette \$7.36 ea.	
●	 <b>77008-XX</b> Semi Open Cassette, 19' \$17.12/ft.	
●	 <b>77007-XX</b> Semi Open Cassette End Cap Set \$8.52/set	
●	 <b>76018-90</b> Cassette Set \$10.34/set	
●	 Endless Chain 25 white plastic or 90 nickel <b>49020-25, 90, 29"</b> \$2.14 ea. <b>49021-25, 90, 39"</b> \$2.48 ea. <b>49022-25, 90, 49"</b> \$3.07 ea. <b>49023-25, 90, 59"</b> \$3.41 ea. <b>49024-25, 90, 69"</b> \$3.59 ea. <b>49025-25, 90, 79"</b> \$3.70 ea. <b>49026-25, 90, 89"</b> \$3.83 ea. <b>49027-25, 90, 99"</b> \$4.15 ea.	
●	 <b>49501-00</b> Tension Device For child safety \$8.19 ea.  \$6.81 ea./box 250	
●	 <b>79005-00</b> Clear Ball Stopper \$1.07 ea.  \$0.89 ea./box 500	
●	 <b>76002-XX</b> Fill up Ring \$1.35 ea.	
●	 <b>76001-XX</b> Bearing Pin \$1.96 ea.	

SEMI OPEN	COMPONENT	PRICE
●	 <b>810219-25</b> Bottom Rail \$4.78/ft.	
●	 <b>810001-25</b> Weight Insert for bottom rail \$7.29/ft.	
●	 <b>810019-25</b> Adhesive Tape for bottom rail \$2.28/yd.	
●	 <b>830004-25</b> End Cap for bottom rail \$1.11 ea.	
●	 <b>810000-00</b> Brush for bottom rail \$1.98/ft.	
●	 2 Piece Outside Mount Side Channel <b>71619-25</b> Bottom \$6.58/ft. <b>71719-25</b> Top \$5.65/ft.	
●	 <b>810119-25</b> One Piece Inside Mount Side Channel, 19' \$12.96/ft.	
●	 <b>79002-25</b> Brush for side channel \$0.68/ft.	
●	 <b>78000-25</b> Motor & lithium battery \$481.18 ea.	
●	 Drive for Mercury Motor <b>78001-25</b> 38mm \$16.41 ea. <b>78020-25</b> 40mm, 50mm \$16.40 ea.	
●	 Crown Adaptor for Mercury Motor <b>78002-25</b> 38mm \$4.96 ea. <b>78010-25</b> 40mm, 50mm \$4.79 ea.	
●	 <b>78003-25</b> Micro USB Cable for Mercury Motor, 9.8 ft. \$20.95 ea.	
●	 <b>78004-59</b> Remote for Mercury Motor, 5 channel, black \$103.64 ea.	

SEE PAGE 105-106 FOR FABRIC OPTIONS.

 **BREAK PACK PRICING**  - Prices with this designation indicate a 20% up charge for broken pack quantities.

# ROLLER SHADES

APOLLO BASIC | **MERCURY DECORATIVE** | ATLANTIS HEAVY DUTY | FABRIC OPTIONS

ROLLER SHADES MERCURY DECORATIVE



Scan for more information on FOREST Mercury Direct Mount Roller Shades

## MERCURY DIRECT MOUNT

- End caps in designer colors
- Contemporary, clean look
- Easy Installation
- 38mm, 42mm and 50mm tube options and a bi-directional clutch



**MOTOR CONTROL AVAILABLE**



### CHAIN DRAW ASSEMBLED PRICING

Includes Essentials fabric (see pages 105-106 for all fabric options), 38mm tubes, roller mechanisms, brackets, bracket covers, and counterweight or bottom rail with end caps. Designer fabrics +20%. Exclusive fabrics +40%. Side channels are additional. Add 10% for 42mm and 15% for 50mm. Freight is additional.

		WIDTH							
		24"	36"	48"	60"	72"	84"	96"	108"
LENGTH	24"	\$251.56	\$258.35	\$265.13	\$271.91	\$278.69	\$285.47	\$292.25	\$299.03
	36"	\$295.55	\$302.33	\$309.11	\$315.89	\$322.67	\$329.45	\$336.23	\$343.01
	48"	\$339.53	\$346.31	\$353.09	\$359.87	\$366.65	\$373.43	\$380.21	\$386.99
	60"	\$383.51	\$390.29	\$397.07	\$403.85	\$410.63	\$417.41	\$424.19	
	72"	\$427.49	\$434.27	\$441.05	\$447.83	\$454.61	\$461.40		
	84"	\$471.47	\$478.25	\$485.03	\$491.82	\$498.60			
	96"	\$515.45	\$522.24	\$529.02	\$535.80				
	108"	\$559.44	\$566.22	\$573.00					



### MOTORIZED ASSEMBLED PRICING















Includes Essentials fabric (see pages 105-106 for all fabric options), 38mm tubes, motor, micro usb cable to charge battery, brackets, bracket covers, counterweight or bottom rail with end caps and remote. Designer fabrics +20%. Exclusive fabrics +40%. Side channels are additional. Add 10% for 42mm and 15% for 50mm. Freight is additional.











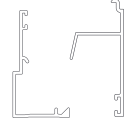

		WIDTH							
		24"	36"	48"	60"	72"	84"	96"	108"
LENGTH	24"	\$853.11	\$871.72	\$890.32	\$908.93	\$927.53	\$946.14	\$964.75	\$983.35
	36"	\$905.07	\$923.68	\$942.28	\$960.89	\$979.49	\$998.10	\$1,016.70	\$1,035.31
	48"	\$957.03	\$975.63	\$994.24	\$1,012.85	\$1,031.45	\$1,050.06	\$1,068.66	\$1,087.27
	60"	\$1,008.99	\$1,027.59	\$1,046.20	\$1,064.80	\$1,083.41	\$1,102.02	\$1,120.62	
	72"	\$1,060.95	\$1,079.55	\$1,098.16	\$1,116.76	\$1,135.37	\$1,153.97		
	84"	\$1,112.90	\$1,131.51	\$1,150.12	\$1,168.72	\$1,187.33			
	96"	\$1,164.86	\$1,183.47	\$1,202.07	\$1,220.68				
	108"	\$1,216.82	\$1,235.43	\$1,254.03					

# ROLLER SHADES



APOLLO BASIC | **MERCURY DECORATIVE** | ATLANTIS HEAVY DUTY | FABRIC OPTIONS

ROLLER SHADES MERCURY DECORATIVE

DIRECT	COMPONENT	PRICE
●	 Aluminum Tube, 19' <b>77003-90</b> 38mm \$4.82/ft. <b>77002-90</b> 42mm \$9.33/ft. <b>77001-90</b> 50mm \$13.08/ft.	
●	 <b>76013-25, 59, 70, 90, 99</b> Clutch Mechanism Plastic, 38mm \$20.39 ea.	
●	 Tube Adaptor <b>76003-25</b> 42mm, 50mm \$1.54 ea.	
●	 Easy Mount End Plug <b>76005-25, 59, 70, 90, 99</b> 38mm \$2.41 ea. <b>76004-25, 59, 70, 90, 99</b> 42mm, 50mm \$3.06 ea.	
●	 <b>76010-25, 59, 70, 90, 99</b> Metal Bracket \$3.78 ea.	
●	 <b>76006-25, 59, 70, 90, 99</b> End Cap, Plastic \$2.55 ea.	
●	 <b>76007-16, 22, 25</b> End Cap Metal \$21.85 ea.	
●	 Endless Chain 25 white plastic or 90 nickel  <b>49020-25, 90, 29"</b> \$2.14 ea. <b>49021-25, 90, 39"</b> \$2.48 ea. <b>49022-25, 90, 49"</b> \$3.07 ea. <b>49023-25, 90, 59"</b> \$3.41 ea. <b>49024-25, 90, 69"</b> \$3.59 ea. <b>49025-25, 90, 79"</b> \$3.70 ea. <b>49026-25, 90, 89"</b> \$3.83 ea. <b>49027-25, 90, 99"</b> \$4.15 ea.	
●	 <b>49501-00</b> Tension Device For child safety \$8.19 ea.  \$6.81 ea./box 250	
●	 <b>79005-00</b> Clear Ball Stopper \$1.07 ea.  \$0.89 ea./box 500	
●	 <b>76002-XX</b> Fill up Ring \$1.35 ea.	
●	 <b>76001-XX</b> Bearing Pin \$1.96 ea.	

DIRECT	COMPONENT	PRICE
●	 <b>810219-25</b> Bottom Rail \$4.78/ft.	
●	 <b>810001-25</b> Weight Insert for bottom rail \$7.29/ft.	
●	 <b>810019-25</b> Adhesive Tape for bottom rail \$2.28/yd.	
●	 <b>830004-25</b> End Cap for bottom rail \$1.11 ea.	
●	 <b>810000-00</b> Brush for bottom rail \$1.98/ft.	
●	 2 Piece Outside Mount Side Channel <b>71619-25</b> Bottom \$6.58/ft. <b>71719-25</b> Top \$5.65/ft.	
●	 <b>810119-25</b> One Piece Inside Mount Side Channel, 19' \$12.96/ft.	
●	 <b>79002-25</b> Brush for side channel \$0.68/ft.	
●	 <b>78000-25</b> Motor & lithium battery \$481.18 ea.	
●	 Drive for Mercury Motor <b>78001-25</b> 38mm \$16.41 ea. <b>78020-25</b> 40mm, 50mm \$16.40 ea.	
●	 Crown Adaptor for Mercury Motor <b>78002-25</b> 38mm \$4.96 ea. <b>78010-25</b> 40mm, 50mm \$4.79 ea.	
●	 <b>78003-25</b> Micro USB Cable for Mercury Motor, 9.8 ft. \$20.95 ea.	
●	 <b>78004-59</b> Remote for Mercury Motor, 5 channel, black \$103.64 ea.	

SEE PAGE 105-106 FOR FABRIC OPTIONS.

 **BREAK PACK PRICING**  - Prices with this designation indicate a 20% up charge for broken pack quantities.

# ROLLER SHADES

APOLLO BASIC | MERCURY DECORATIVE | **ATLANTIS HEAVY DUTY** | FABRIC OPTIONS



Scan for more information on  
FOREST Atlantis HD Motorized  
Roller Shades



25  
White



## ATLANTIS HEAVY DUTY MOTORIZED ROLLER SHADES

- Atlantis is a heavy duty system with a maximum weight of 45 lbs. Includes a 10-year warranty.
- Easy Installation with universal adjustable brackets
- 50mm and 60mm tube options and a bi-directional clutch

### CASSETTE MOUNT ASSEMBLED PRICING

Includes Essentials fabric (see pages 105-106 for all fabric options), tube, roller mechanism, brackets, bracket covers, cassette cover, motor, Diamond remote or wall switch, & bottom rail w/ end caps. Designer fabrics +20%. Exclusive fabrics +40%. Side channels are additional. Freight is additional.

LENGTH	WIDTH									
	50 mm diameter tube included. +20% for 60 mm				60 mm diameter tube included and recommended at these widths					
	24"	36"	48"	60"	72"	84"	96"	108"	120"	
24"	\$1,231.42	\$1,271.67	\$1,311.92	\$1,352.17	\$1,392.41	\$1,440.41	\$1,481.15	\$1,521.88	\$1,562.62	
36"	\$1,283.36	\$1,323.61	\$1,363.86	\$1,404.10	\$1,444.35	\$1,492.35	\$1,533.08	\$1,573.82	\$1,614.56	
48"	\$1,335.30	\$1,375.55	\$1,415.79	\$1,456.04	\$1,496.29	\$1,544.29	\$1,585.02	\$1,625.76	\$1,666.50	
60"	\$1,387.24	\$1,427.48	\$1,467.73	\$1,507.98	\$1,548.23	\$1,596.22	\$1,636.96	\$1,677.70	\$1,718.43	
72"	\$1,439.17	\$1,479.42	\$1,519.67	\$1,559.92	\$1,600.16	\$1,648.16	\$1,688.90	\$1,729.63	\$1,770.37	
84"	\$1,491.11	\$1,531.36	\$1,571.61	\$1,611.85	\$1,652.10	\$1,700.10	\$1,740.84	\$1,781.57	\$1,822.31	
96"	\$1,543.05	\$1,583.30	\$1,623.54	\$1,663.79	\$1,704.04	\$1,752.04	\$1,792.77	\$1,833.51	\$1,874.25	
108"	\$1,594.99	\$1,635.23	\$1,675.48	\$1,715.73	\$1,755.98	\$1,803.97	\$1,844.71	\$1,885.45	\$1,926.18	
120"	\$1,646.92	\$1,687.17	\$1,727.42	\$1,767.67	\$1,807.92	\$1,855.91	\$1,896.65	\$1,937.38	\$1,978.12	
132"	\$1,698.86	\$1,739.11	\$1,779.36	\$1,819.60	\$1,859.85	\$1,907.85	\$1,948.59	\$1,989.32	\$2,030.06	
144"	\$1,750.80	\$1,791.05	\$1,831.29	\$1,871.54	\$1,911.79	\$1,959.79	\$2,000.52	\$2,041.26	\$2,082.00	

### DIRECT MOUNT ASSEMBLED PRICING

Includes Essentials fabric (see pages 105-106 for all fabric options), tube, roller mechanism, brackets, bracket covers, motor, Diamond remote or wall switch, & bottom rail with end caps. Designer fabrics +20%. Exclusive fabrics +40%. Side channels are additional. Freight is additional.











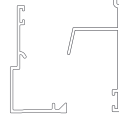

LENGTH	WIDTH									
	50 mm diameter tube included. +20% for 60 mm				60 mm diameter tube included and recommended at these widths					
	24"	36"	48"	60"	72"	84"	96"	108"	120"	
24"	\$1,205.34	\$1,231.96	\$1,258.59	\$1,285.21	\$1,311.84	\$1,346.21	\$1,373.33	\$1,400.45	\$1,427.58	
36"	\$1,257.28	\$1,283.90	\$1,310.52	\$1,337.15	\$1,363.77	\$1,398.14	\$1,425.27	\$1,452.39	\$1,479.51	
48"	\$1,309.21	\$1,335.84	\$1,362.46	\$1,389.09	\$1,415.71	\$1,450.08	\$1,477.21	\$1,504.33	\$1,531.45	
60"	\$1,361.15	\$1,387.78	\$1,414.40	\$1,441.02	\$1,467.65	\$1,502.02	\$1,529.14	\$1,556.27	\$1,583.39	
72"	\$1,413.09	\$1,439.71	\$1,466.34	\$1,492.96	\$1,519.59	\$1,553.96	\$1,581.08	\$1,608.20	\$1,635.33	
84"	\$1,465.03	\$1,491.65	\$1,518.28	\$1,544.90	\$1,571.52	\$1,605.90	\$1,633.02	\$1,660.14	\$1,687.26	
96"	\$1,516.96	\$1,543.59	\$1,570.21	\$1,596.84	\$1,623.46	\$1,657.83	\$1,684.96	\$1,712.08	\$1,739.20	
108"	\$1,568.90	\$1,595.53	\$1,622.15	\$1,648.77	\$1,675.40	\$1,709.77	\$1,736.89	\$1,764.02	\$1,791.14	
120"	\$1,620.84	\$1,647.46	\$1,674.09	\$1,700.71	\$1,727.34	\$1,761.71	\$1,788.83	\$1,815.95	\$1,843.08	
132"	\$1,672.78	\$1,699.40	\$1,726.03	\$1,752.65	\$1,779.27	\$1,813.65	\$1,840.77	\$1,867.89	\$1,895.02	
144"	\$1,724.72	\$1,751.34	\$1,777.96	\$1,804.59	\$1,831.21	\$1,865.58	\$1,892.71	\$1,919.83	\$1,946.95	

# ROLLER SHADES

APOLLO BASIC | MERCURY DECORATIVE | **ATLANTIS HEAVY DUTY** | FABRIC OPTIONS

ROLLER SHADES ATLANTIS HEAVY DUTY MOTORIZED

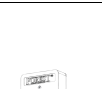
ATLANTIS	COMPONENT	PRICE
●	 <p>Aluminum Tube, 19'  <b>815019-00</b> 50mm for shades up to 72"  <b>816019-00</b> 60mm for shades up to 144"</p>	\$12.96/ft. \$16.05/ft.
●	 <p><b>82CL01-25</b> Left  <b>82CR01-25</b> Right                      Standard Ceiling/Wall Idler Brackets</p>	\$47.49 ea.
●	 <p><b>820003-25</b>                      Middle Adjustable Ceiling Cassette Idler Bracket</p>	\$58.11 ea.
●	 <p><b>82CL00-25</b> Left  <b>82CR00-25</b> Right                      Standard Ceiling/Wall Motor Bracket</p>	\$28.87 ea.
●	 <p><b>820004-25</b>                      Middle Adjustable Ceiling Connecting Bracket</p>	\$48.82 ea.
●	 <p><b>820005-25</b>                      Middle Adjustable Ceiling Cassette Connecting Bracket</p>	\$53.17 ea.
●	 <p><b>810319-25</b>                      Cassette Cover, 19'</p>	\$13.25/ft.
●	 <p><b>830001-25</b>                      Bracket End Cap</p>	\$3.48 ea.
●	 <p><b>830002-25</b>                      Middle Bracket Cover</p>	\$3.32 ea.
●	 <p><b>810219-25</b>                      Bottom Rail</p>	\$4.78/ft.
●	 <p><b>810001-25</b>                      Weight Insert for bottom rail</p>	\$7.29/ft.
●	 <p><b>810019-25</b>                      Adhesive Tape for bottom rail and tube attachment</p>	\$2.28/yd.
●	 <p><b>830004-25</b>                      End Cap for bottom rail</p>	\$1.11 ea.
●	 <p><b>810000-00</b>                      Brush for bottom rail</p>	\$1.98/ft.
●	 <p><b>810119-25</b>                      One Piece Inside Mount Side Channel, 19'</p>	\$12.96/ft.

ATLANTIS	COMPONENT	PRICE
●	 <p>2 Piece Outside Mount Side Channel  <b>71619-25</b> Bottom \$6.58/ft.  <b>71719-25</b> Top \$5.65/ft.</p>	
●	 <p><b>79002-25</b>                      Brush for side channel</p>	\$0.68/ft.
●	 <p><b>62901-25</b>                      Forest Tubular Motor built-in RF receiver, 35mm, 110v, 6 Nm</p>	\$585.58 ea. 1/box
●	 <p><b>835000-00</b>                      50mm Motor Adaptor</p>	\$27.62 ea.
●	 <p><b>835001-00</b>                      50mm Idler</p>	\$2.73 ea.
●	 <p><b>835002-00</b>                      50mm Connector Idler</p>	\$2.73 ea.
●	 <p><b>835003-00</b>                      50mm Adjustable Idler</p>	\$34.03 ea.
●	 <p><b>836000-00</b>                      60mm Motor Adaptor</p>	\$32.18 ea.
●	 <p><b>836001-00</b>                      60mm Idler</p>	\$4.42 ea.
●	 <p><b>52931-25D</b> white  <b>59D</b> black +10%                      Diamond Remote RF, 15 channel w/ holder Range 98'</p>	\$344.48 ea. 1/box
●	 <p><b>52933-25</b> white  <b>59</b> black +10%                      Diamond Wall Switch 15 channel</p>	\$169.55 ea. 1/box
●	 <p><b>52947-25</b>                      Wireless Connector One-way transmitter to control drapery by third party app or home automation. Works with all Forest Shuttle &amp; tubular motors.</p>	\$213.35 ea. 1/box Smart plug included

SEE PAGE 105-106 FOR FABRIC OPTIONS.

# ROLLER SHADES

APOLLO BASIC | MERCURY DECORATIVE | ATLANTIS HEAVY DUTY | **FABRIC OPTIONS**

## FABRIC OPTIONS FOR ROLLER SHADES

**IN STOCK FABRICS** are divided across three collections – Essentials, Designer and Exclusive to meet your specific needs for value and style. Contact customer service for a swatch card, [customerservice@forestdh.com](mailto:customerservice@forestdh.com).

**SPECIAL ORDER FABRICS** – choose from among hundreds of fabrics in many types, colors and patterns. Contact customer service for a binder, pricing and lead times, [customerservice@forestdh.com](mailto:customerservice@forestdh.com).

All fabrics are suitable for any of our roller shade systems.

Fabric images on pages 105-106 are a close representation, but for best results please order one of our swatch cards. Contact [customerservice@forestdh.com](mailto:customerservice@forestdh.com) to place your order.



### ESSENTIALS COLLECTION

The Forest Essentials Fabric Collection offers quality at a value. Choose a 3% screen, a sheer or a blackout fabric to coordinate with your room design. The fabrics in this collection are included in roller shade assembled pricing grids.

#### SCREENS



Bone White  
**74002-99**  
W: 118"



Vanilla Creme  
**74004-97**  
W: 118"

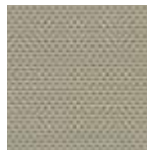

Copenhagen  
**74020-81**  
W: 98"

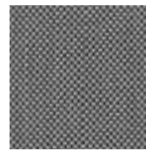

Charcoal  
**74003-55**  
W: 118"

#### SHEERS



White Linen  
**74007-25**  
W: 110"



Broad Lines  
**74008-25**  
W: 94"



Fine Lines  
**74009-25**  
W: 94"

#### BLACKOUT

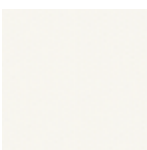

Frost  
**74005-01**  
W: 118"

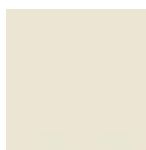

Ecrú  
**74001-98**  
W: 108"

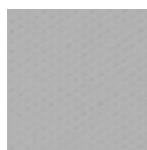

Pewter  
**74006-08**  
W: 118"

# ROLLER SHADES

APOLLO BASIC | MERCURY DECORATIVE | ATLANTIS HEAVY DUTY | **FABRIC OPTIONS**



## DESIGNER COLLECTION

The Forest Designer Fabric Collection offers the latest styles and colors of roller shade fabric. There is a 20% premium charge for fabrics in the Designer Collection.

### SCREENS



Richland  
75001-01  
W: 118"



Pearland  
75001-02  
W: 118"



Hamburg  
75001-03  
W: 98"

### SHEERS

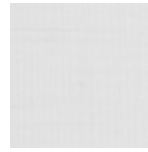

Singapore  
75001-04  
W: 94"

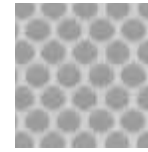

Manila  
75001-05  
W: 110"



Mumbai  
75001-06  
W: 118"

### WOVENS



Sao Paulo  
75001-07  
W: 118"



Salvador  
75001-08  
W: 118"



Asheville  
75001-09  
W: 118"

### NATURALS



Macau  
75001-10  
W: 70"



Tokyo  
75001-11  
W: 78"

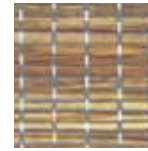

Taipei  
75001-12  
W: 78"

### BLACKOUT



Woodbury  
75001-13  
W: 118"

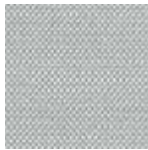

Seaside  
75001-14  
W: 110"



Capetown  
75001-15  
W: 110"



## EXCLUSIVES COLLECTION

The Forest Exclusive Fabric Collection offers distinctive fabrics. There is a 40% premium charge for fabrics in the Exclusives Collection.

### SCREEN



Moscow  
76001-10  
W: 98"

### WOVEN



Montauk  
76001-20  
W: 110"

### BLACKOUT



Whitehall  
76001-30  
W: 94.5"



## APPENDIX WITH ADDITIONAL INFORMATION



Terms & Conditions



Quoting & Ordering  
Information

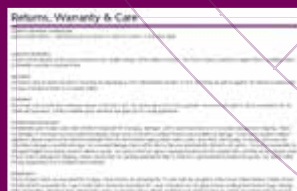

Returns, Warranty  
& Care





In this section you will find Forest terms & conditions, ordering instructions, warranty information, return instructions, care instructions, ripplefold carrier counts, and many marketing and technical support options.

## Ripplefold Carrier Count Charts



## Product Support



## Child Safety

## TERMS & CONDITIONS

Applicant, to induce Forest Drapery Hardware (FDH) to consider providing goods on credit to Applicant, hereby agrees for itself, its successors, and permitted assigns, that the following terms and conditions shall apply to all sales of goods (the "Goods") by FDH to applicant.

1. Applicant is applying for credit for business purposes. Applicant authorizes all financial institutions and business entities of which FDH may from time to time make inquiry to provide FDH such financial information, as FDH deems necessary to make credit decisions. FDH has no obligation to extend credit to Applicant and may in its sole discretion suspend, terminate or reduce the limits of any extensions of credit at any time and withhold shipments of Goods ordered, or require cash in advance, in the event FDH, in its sole discretion, finds Applicant's financial condition to be unsatisfactory.
2. FDH will provide to Applicant an itemized invoice for each sale. If Applicant does not give written notice to FDH within fifteen (15) calendar days from the date of such invoice of any objection to the Goods listed, the receipt thereof, that such purchase was unauthorized or any other objection, all such objections shall be deemed waived. Applicant waives any and all right to set off claims, which it may assert against FDH, and/or to withhold payment to FDH based on a claim that FDH is indebted to Applicant. No claim asserted by Applicant against FDH shall relieve Applicant of its obligation to make timely payments to FDH.
3. Except as otherwise set forth in a FDH Invoice, payment is due by the 30th day following the date of the invoice. Payments become past due after the 30th day. Applicant agrees that all amounts in past due shall bear interest at 1.5% per month pre- and post-judgment until paid and agrees to pay FDH, in addition to the amount due, attorneys' fees of fifteen percent (15%) of the amount due, or the maximum amount allowed by law, whichever is greater, in the event the account is placed in collections with an attorney, or any other means of collection, and also to pay any and all attorneys' fees and costs associated with post-judgment collection preparation and recording fees. Applicant agrees that all payments shall be applied to Applicant's account as designated in writing and if not designated in writing then FDH shall apply said payments to the most outstanding invoices. This Agreement shall be deemed fully executed and performed in Bartow County, Georgia, and will be governed and construed in accordance with the laws of Georgia. Applicant agrees to examine all invoices and statements promptly upon receipt and to notify FDH immediately at any failure of delivery, shortage, discrepancy or error and further agrees that such invoice or statement shall be presumed correct unless Applicant shall notify FDH in writing of such failure of delivery, shortage, discrepancy or error within thirty (30) calendar days of Applicant's receipt of such invoice or statement. Use of materials by Applicant shall constitute a waiver of any error in shipment or defect in materials, which might have been determined by a prompt and diligent inspection thereof.
4. Any waiver or non-enforcement by FDH of a breach, default or term under this Agreement shall not be deemed a waiver of any subsequent breach or default of enforcement of such term and FDH shall only be deemed to have given as much in writing executed by FDH providing for such waiver. If any provision of this Agreement is waived by FDH or is held to be invalid or unenforceable, all other provisions shall nevertheless continue in full force and effect as if such provision were not contained herein.
5. This Agreement contains the entire agreement and understanding between FDH and Applicant with respect to the sale of Goods by FDH to Applicant (other than payment terms and delivery dates to be set forth in FDH invoices), supersedes all prior agreements, commitments, representations and discussions between FDH and Applicant and is not assignable by Applicant without the prior written consent of FDH. No modifications, amendments of or additions to this agreement will be binding on FDH unless such modification, amendment or addition is in writing executed by FDH. Without limitation of the foregoing, the terms hereof shall not be modified, amended or added to by the terms of any purchase order or similar document submitted by Applicant to FDH. The terms here of shall be altered or interpreted by reference to any course of dealing between FDH and Applicant of industry practice. Any action by Applicant instituted against FDH arising from Goods sold must be commenced within one (1) year from date of delivery of the subject of Goods.
6. Applicant shall have seven (7) calendar days from the date of delivery to reject Goods as nonconforming. Such rejection must be in writing received by FDH within such seven (7) calendar days, and specify the Goods rejected and the specific nonconformity asserted and the subject Goods must be received by FDH within ten (10) calendar days from the delivery date of Goods. All Goods not so rejected shall conclusively be deemed to have been accepted. In order to effect such rejection, the Goods returned must be accompanied by a copy of the original invoice or other proof of purchase by Applicant. No charges or expenses incident to any claims will be allowed unless approved by an authorized representative of FDH. Goods shall not be returned to FDH without FDH permission and such returns will only be accepted when return authorization numbers, given by FDH, is mentioned on the Goods and bill of lading. Physical acceptance by FDH of Goods returned may in no way be deemed agreement by FDH of any claim by Applicant of nonconformity.
7. FDH shall have a reasonable time after receipt of proper notice of rejection of nonconformity Goods of revocation of acceptance of nonconformity Goods to repair or replace the Goods or refund the purchase price, with the remedy to be selected by FDH in its sole discretion. If Applicant otherwise has an outstanding balance, the refund shall be in the form of a credit to Applicant's account.
8. Applicant is responsible for determining the Goods it chooses to purchase and for what purposes those Goods will be used and Applicant will not be relying on the skill or judgment of FDH to select or furnish Goods suitable for any particular purpose. FDH MAKES NO REPRESENTATIONS OR WARRANTIES, EXPRESS OR IMPLIED, INCLUDING BUT NOT LIMITED TO WARRANTIES OF FITNESS OR SUITABILITY FOR ANY PURPOSE, AND/OR THE MERCHANTABILITY OF ANY GOODS. Applicant agrees that its sole and exclusive remedy against FDH for defective or nonconforming Goods shall be repair or replacement of such Goods, or refund of purchase price, with the remedy to be selected by FDH at its sole discretion. Applicant hereby waives all other remedies, and in no event shall FDH be liable for any negligence or general, incidental, special, consequent or other damages suffered by Applicant or any other party for lost profit, sales, labor, injury to person or property or any other loss. FDH may deliver certain third-party manufacturer warranties to Applicant, but FDH shall have no liability under such warranties.
9. The undersigned unconditionally personally guarantees the timely payment of all amounts due from Applicant to FDH and agrees to be jointly and severally liable with the Applicant to FDH for any debt owed by the Applicant, The undersigned agrees to pay reasonable attorneys' fees equal to 15% of the outstanding principal and interest owed by the Applicant in the event that the Applicant's account is placed in collections with an attorney or any other means of collection. This personal guarantee may only be revoked in writing sent by certified mail to FDH. Said revocation shall not be effective as to any balance owned prior to receipt of said revocation. The undersigned hereby expressly waives notice of acceptance of this instrument, notice of any default, non-payment, partial payment, presentment, protest, demand and any and all other notices whatsoever.

# APPENDIX

TERMS & CONDITIONS | **ORDERING INFORMATION** | RETURNS, WARRANTY & CARE | CARRIER COUNTS | PRODUCT SUPPORT

## ORDERING INFORMATION



### OPEN AN ACCOUNT

Forest sells to the trade only. If you are a member of the trade and want to open an account, consider that volume of purchases from Forest will determine your discount structure. Using a local distributor may save you shipping time and provide better pricing. See below to find a distributor in your area. If you would like to open an account with Forest, scan this code to go to the new customer forms on the Forest website. [forestdh.com/new-customer-forms](http://forestdh.com/new-customer-forms).



### FIND A DISTRIBUTOR

Buying from a local distributor may save you shipping time and provide better pricing. Need to find a distributor of Forest products? If so, scan this code to find a distributor in your area. [forestdh.com/find-a-distributor](http://forestdh.com/find-a-distributor)

### TO GET A QUOTE OR TO PLACE AN ORDER

We only accept orders in writing, not by phone. Please e-mail your customer service representative or [customerservice@forestdh.com](mailto:customerservice@forestdh.com) with your order information.

### QUESTIONS ON AN ORDER

E-mail or call with your sales order number and we will be happy to help! Our office is open M-F, 8:30 am - 5:30 pm Eastern Time.  
P: 678-721-0004  
E: [customerservice@forestdh.com](mailto:customerservice@forestdh.com)

## RETURNS, WARRANTY & CARE

### FREIGHT/SHIPPING

Orders will be shipped via the most economical way. Freight charges will be added to invoice. The Forest Drapery Hardware Freight Policy is available online at [forestdh.com/new-customer-forms](http://forestdh.com/new-customer-forms).

### RETURNS

All returns must be approved prior to returning by requesting an RGA authorization number. A 25% restocking fee will be applied. No returns accepted after 30 days of receipt of order or on custom orders.

### PAYMENT

We accept Visa, Mastercard, American Express & Discover Card. Our invoice price is for check payment. We reserve the right to add a convenience fee for credit card payments. Credit is available upon submittal and approval of a credit application.

### SHORTAGES/DAMAGES

Immediately upon receipt, your order should be inspected for shortages, damages, and to insure that there is no concealed damage from shipping. Claims on damages or shortages must be made within 3 days. Please note on the Bill of Lading if there is any possibility of damage. If your driver requires a digital signature, please request an EXCEPTION NUMBER from the driver before signing. Black marks, holes, open ends, over-boxing, re-taping, torn boxes etc., constitutes damage or possible shortage. No concealed damage claims will be filed as they are automatically denied by all carriers. You will be responsible for damaged freight not properly noted on delivery receipt. Our policy is that we replace damaged products per the original order and ship via the original carrier. If your order is damaged in shipping, carriers require that ALL packing materials be kept in order for a representative to inspect the goods. You will be billed for any replacement cost if a freight claim is denied. Replacements for undelivered goods will be sent after freight company has had a reasonable time to deliver order.

### WARRANTY

Forest Drapery Tracks are warranted for 10 years. Forest Motors are warranted for 10 years with the exception of the Forest Lithium Battery Tubular Motor for RBS which is warranted for 1 year. Forest Roller Shades are warranted for 1 year. Warranties do not apply to wear resulting from normal usage, damage from mishandling, alterations from original state, abuse, or exposure due to climate conditions over which we have no control. No Forest products are warranted for outdoor use. Forest Drapery Hardware does not cover the shipping costs for the return or replacement of warranty items.

### CARE

Products can be cleaned with a damp cloth. Do not use any type of cleaner or solvent.

# APPENDIX

TERMS & CONDITIONS | ORDERING INFORMATION | RETURNS, WARRANTY & CARE | **CARRIER COUNTS** | PRODUCT SUPPORT

## RIPPLEFOLD CARRIER COUNTS

For Overlap Masters

No. of Full Spaces Required	Fabric Width Hemmed	Panel Coverage 120% Fullness	Panel Coverage 100% Fullness	Panel Coverage 80% Fullness	Panel Coverage 60% Fullness	* No. of Carriers
7	35 1/2	11-14	12-16	14-17	14-19	8
9	44	15-18	17-20	18-22	20-24	10
11	52 1/2	19-21	21-24	23-27	25-30	12
13	61	22-25	25-28	28-32	31-35	14
15	69 1/2	26-29	29-32	33-36	36-40	16
17	78	30-33	33-37	37-41	41-45	18
19	86 1/2	34-36	38-41	42-46	46-51	20
21	95	37-40	42-45	47-51	52-56	22
23	103 1/2	41-44	46-50	52-55	57-61	24
25	112	45-48	51-54	56-60	62-66	26
27	120 1/2	49-51	55-58	61-65	67-72	28
29	129	52-55	59-62	66-70	73-77	30
31	137 1/2	56-59	63-66	71-74	78-82	32
33	146	60-63	67-71	75-79	83-87	34
35	154 1/2	64-66	72-75	80-84	88-93	36
37	163	67-70	76-79	85-89	94-98	38
39	171 1/2	71-74	80-84	90-93	99-103	40
41	180	75-78	85-88	94-98	104-108	42
43	188 1/2	79-81	89-92	99-103	109-114	44
45	197	82-85	93-96	104-108	115-119	46
47	205 1/2	86-89	97-101	109-112	120-124	48
49	214	90-93	102-105	113-117	125-129	50
51	222 1/2	94-96	106-109	118-122	130-135	52
53	231	97-100	110-113	123-127	136-140	54
55	239 1/2	101-104	114-118	128-131	141-145	56

No. of Full Spaces Required	Fabric Width Hemmed	Panel Coverage 120% Fullness	Panel Coverage 100% Fullness	Panel Coverage 80% Fullness	Panel Coverage 60% Fullness	* No. of Carriers
57	248	105-108	119-122	132-136	146-150	58
59	256 1/2	109-111	123-126	137-141	151-156	60
61	265	112-115	127-130	142-146	157-161	62
63	273 1/2	116-119	131-136	147-150	162-166	64
65	282	120-123	137-139	151-155	167-171	66
67	290 1/2	124-126	140-143	156-160	172-176	68
69	299	127-130	144-147	161-165	177-182	70
71	307 1/2	131-134	148-152	166-169	183-187	72
73	316	135-138	153-156	170-174	188-192	74
75	324 1/2	139-141	157-160	175-179		76
77	333	142-145	161-164	180-184		78
79	341 1/2	146-149	165-168	185-188		80
81	350	150-153	169-173	189-193		82
83	358 1/2	154-156	174-177			84
85	367	157-160	178-181			86
87	375 1/2	161-164	182-186			88
89	384	165-168	187-190			90
91	392 1/2	169-171				92
93	401	172-175				94
95	409 1/2	176-179				96
97	418	180-183				98
99	426 1/2	184-186				100
101	435	187-190				102

\* Includes one carrier (button position only) for attachment to master.

# APPENDIX

TERMS & CONDITIONS | ORDERING INFORMATION | RETURNS, WARRANTY & CARE | **CARRIER COUNTS** | PRODUCT SUPPORT

## RIPPLEFOLD CARRIER COUNTS

For Butt Masters

No. of Full Spaces Required	Fabric Width Hemmed	Panel Coverage 120% Fullness	Panel Coverage 100% Fullness	Panel Coverage 80% Fullness	Panel Coverage 60% Fullness	* No. of Carriers
7	34	13-13	13-14	13-16	16-18	8
9	42 1/2	14-16	15-19	17-21	19-23	10
11	51	17-20	20-23	22-26	24-28	12
13	59 1/2	21-24	24-27	27-30	29-34	14
15	68	25-28	28-31	31-35	35-39	16
17	76 1/2	29-31	32-36	36-40	40-44	18
19	85	32-35	37-40	41-45	45-49	20
21	93 1/2	36-39	41-44	46-49	50-55	22
23	102	40-43	45-48	50-54	56-60	24
25	110 1/2	44-46	49-53	55-59	61-65	26
27	119	47-50	54-57	60-64	66-70	28
29	127 1/2	51-54	58-61	65-68	71-76	30
31	136	55-58	62-65	69-73	77-81	32
33	144 1/2	59-61	66-70	74-78	82-86	34
35	153	62-65	71-74	79-83	87-91	36
37	161 1/2	66-69	75-78	84-87	92-97	38
39	170	70-73	79-82	88-92	98-102	40
41	178 1/2	74-76	83-87	93-97	103-107	42
43	187	77-80	88-91	98-102	108-112	44
45	195	81-84	92-95	103-106	113-118	46
47	204	85-88	96-99	107-111	119-123	48
49	212 1/2	89-91	100-104	112-116	124-128	50
51	221	92-95	105-108	117-121	129-133	52
53	229 1/2	96-99	109-112	122-125	134-139	54
55	238	100-103	113-116	126-130	140-144	56

No. of Full Spaces Required	Fabric Width Hemmed	Panel Coverage 120% Fullness	Panel Coverage 100% Fullness	Panel Coverage 80% Fullness	Panel Coverage 60% Fullness	* No. of Carriers
57	246 1/2	104-106	117-121	131-135	145-149	58
59	255	107-110	122-125	136-140	150-154	60
61	263 1/2	111-114	126-129	141-144	155-160	62
63	272	115-118	130-133	145-149	161-165	64
65	280 1/2	119-121	134-138	150-154	166-170	66
67	289	122-125	139-142	155-159	171-175	68
69	297 1/2	126-129	143-146	160-163	176-181	70
71	306	130-133	147-150	164-168	182-186	72
73	314 1/2	134-136	151-155	169-173	187-191	74
75	323	137-140	156-159	174-178	192-196	76
77	331 1/2	141-144	160-163	179-182		78
79	340	145-148	164-167	183-187		80
81	348 1/2	149-151	168-172	188-192		82
83	357	152-155	173-176	193-197		84
85	365 1/2	156-159	177-180			86
87	374	160-163	181-184			88
89	382 1/2	164-166	185-189			90
91	391	167-170	190-193			92
93	399 1/2	171-174				94
95	408	175-178				96
97	416 1/2	179-181				98
99	425	182-185				100
101	433 1/2	186-189				102
103	442	190-193				104

\* Includes one carrier (button position only) for attachment to master.

# APPENDIX

TERMS & CONDITIONS | ORDERING INFORMATION | RETURNS, WARRANTY & CARE | CARRIER COUNTS | **PRODUCT SUPPORT**

## PRODUCT SUPPORT



### FOREST WEBSITE – FORESTDH.COM

Catalog & Spec Sheets  
 Assembly & Installation Instructions  
 Technical Manuals  
 Trade Show Schedule .....



### PRODUCT CATALOGS

The Forest product catalog contains over 100 pages of product available in our Atlanta warehouse.  
 See the catalog in print or online .....

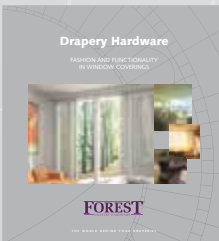

### DECORATIVE HARDWARE FINISH SWATCH BINDER

The Forest finish swatch binder contains physical samples of each finish in our decorative metal and wood collections, a swatch card of our in-stock roller shade fabrics, and a product catalog.

999001-00 ..... \$100.00 each



### ROLLER SHADE FABRIC SWATCH CARD & BINDER

The Forest roller shade fabric swatch card allows you to see and feel our stock fabrics ..... email customerservice@forestdh.com

The Forest designer fabric swatch binder contains more than 100 roller shade fabrics available to order. Approximate lead time for these fabrics is 2 weeks. .... \$100.00 each



**PRODUCT SUPPORT**

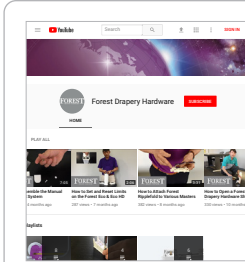

**FOREST YouTube CHANNEL**

Programming, Assembly, Tips & Tricks . . . . .



**USC DRAPERY HARDWARE SAMPLE PACKAGE**

Kit includes a wall display with 10 hardware sample boards, a finish sample binder with a catalog, and a motorized track sample.

**FDHP-2021** . . . . . \$500.00

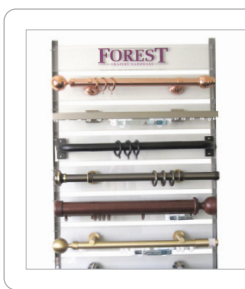

**DRAPERY HARDWARE WALL DISPLAY**

Boards (11) – Top logo board plus ten acrylic boards with hardware set attached, 25 1/4”W x 3 7/8”H

Rails – Pair of wall mount rails holds the 11 boards, 53 1/8”H

**B0005-00 + B0008-00** . . . . . \$250.00/set



**PRODUCT TRAINING**

Forest product training with a United Supply Company Territory Manager. Call to schedule an appointment 1-800-334-1207.



**CHILD SAFETY**

All Forest custom assembled products containing cords meet ANSI/WCMA A100.1-2018 child safety standards and include a tension device and a warning label like the one to the right.



WWW.UNITEDSUPPLYCO.COM



10701 Texland Boulevard  
Charlotte, NC 28273  
P: 800-334-1207  
F: 800-400-1795

2021FDHB



FOREST DRAPERY HARDWARE  
RETAIL PRICE GUIDE - VOLUME 21