



 **KIRSCH**[®]
DRAPERY HARDWARE

AMP[™] Motorization

AMP™ Motorization at a Glance

To help determine which system is right for your project, use the guideline below to select the best fit. For more detailed information about each track, please visit our resource library at kirsch.com.

AMP™ Motorization Track Styles	Designer Metals™ Estate™	Wood Trends™ Estate™	Wrought Iron Estate™	Chroma/Varia	Architrac® 94001
What is your preferred size?					
1 3/8"	•	•	•	n/a	n/a
2"	•	•			n/a
What is your preferred Drapery Heading type?					
Pleated	•	•	•	•	•
Ripplefold™	•	•	•	•	•
What is your mounting location?					
Ceiling Mount*	•	•	•	•	•
Wall Mount	•	•	•	•	•
Recessed Mount*	n/a	n/a	n/a	n/a	•
What is your preferred look?					
With rings (2" Estate™ only)	•	n/a	n/a	n/a	n/a
Without rings	•	•	•	•	•

*Final choices may be limited for ceiling mounted Estate™ Rods.

Master Carrier

Draw	Overlap Master	Butt Master
One Way	•	•
Two Way	•	•

Estate™ Track Performance with AMP™ Motorization

Draw	Minimum Track Length	Maximum Track Length	Maximum Fabric Length	Maximum lbs per Foot
One Way	18"	16'	64 lbs	4 lbs
Two Way	18"	16'	64 lbs	4 lbs

Architrac® Track Performance with AMP™ Motorization

Draw	Minimum Track Length	Maximum Track Length	Maximum Fabric Length	Maximum lbs per Foot*
One Way	18"	16'	64 lbs	4 lbs
Two Way	18"	16'	64 lbs	4 lbs

*For AMP™ only.

AMP™ Motorization

Why AMP™?

The slim design of the quiet, yet powerful motor and the position on the track allows the motor to tuck seamlessly behind your drapery panel so you'll never have to sacrifice your style or comfort. For safety measures, you're able to move the draperies with a gentle tug, allowing for operation when a remote is not present or if a guest is unaware of the motorization feature. The dual battery and AC power sources allows operation in case of a power outage so draperies may be opened in the event of an emergency. AMP™ Motorization is available on our most popular traversing tracks, Estate and Architrac® Series 94001 and in drapery header styles Ripplefold™ and pleated for a variety of styling options. This is comfortable living at its finest.

For AMP™ Motorization brochure, programming instructions and installation instructions, please visit the drapery hardware resource library at kirsch.com.

Benefits & Features

AMP™ Motorization

- Motor mounts to the back of the track which allows a seamless look between motorized and manual traverse rods
- Drapery fabrication does not need to change between manually controlled draperies and motorized draperies; No additional returns or any special instructions
- Limits are set automatically after installation
- Remote control is radio frequency and easily pairs with the motor
- Tug feature; when drapery is pulled the motor will traverse the drapery
- AMP™ App with AMP™ USB Bridge
- Architrac® Series 94001 Rods with AMP™ cannot be bent or curved

Frequently Asked Questions

What is the weight capacity?

64 lbs Motor is rated to 64 lbs. Be sure not to exceed the Estate or Architrac track specifications to ensure your motor operates optimally.

Can you double the weight capacity by using two motors?

No Only use one motor per rod.

Does AMP™ offer limit setting?

Yes The motor automatically sets its limits.

Does AMP™ offer touch control?

Yes The tug feature allows you to pull on the drapery and the motor will automatically open or close your draperies.

How long is the power cord?

6 ft The durable, non-extendable power cord is extra long for out of reach places. Any extra can be rolled and secured for a tidy look. Cable extensions are available in 15", 4', 10' and 20' lengths to reach outlets that are farther away from the motor.

Is there a wall switch?

Yes There are Flush Mount and Surface Mount Wall Switches available.

Does AMP™ offer a warranty?

Yes See the Kirsch Warranty document for more information.

Download the AMP™ APP to get started



AMP™ Motorization Overview

Overview

- Soft start/stop & manual operation
- Tug feature: when drapery is pulled the motor will traverse the drapery
- Automatic limits on end stop
- Favorite/intermediate position
- Dry contact for external control
- RF Remote and wall switches
- Setting with buttons on motor units
- Setting with external dry contact switch
- LED Indicators
- One-Way and Two-Way Draw
- Pleated
- Ripplefold™
- AMP™ App with AMP™ USB Bridge

Available Colors

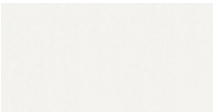

White

Side View



Front View

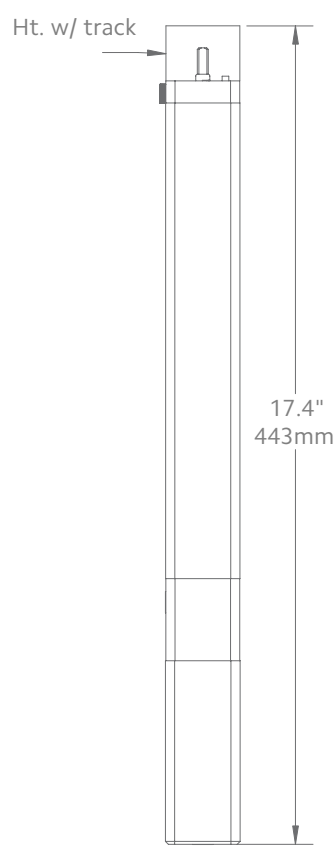

Bottom View

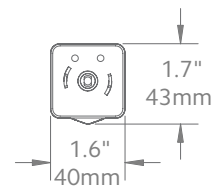

Motor Unit Product No.

AMP™ Drapery Motor 62001300

Technical Specs AMP™ Motor

Power Supply DC 16.5V-0.89A
(100-240VAC 50/60Hz 0.5A)

Amperage 2.55Ah

Average Linear Speed 7.8inches/sec

Power Consumption 40 watts

Torque 1.2Nm

Power Cable Length 6 feet

Variable Speed 80, 100 & 120 rpm

Certifications UL/CE

Max. Track Length Estate™ - 16 ft
Architrac™ 94001 - 16 ft

Max. Load 64 lbs

Follow track specifications for drapery weight.

Bracket Spacing & Mount Options

Place brackets at each end. On the ends where the drapery will stack, place the next bracket at a maximum of 24" from the first bracket, then place remaining brackets at 48" intervals over the remainder of the track. Spacing may need to be shortened for heavier draperies. All mounting options are compatible with our AMP™ Motorization.



Wall Mount using parts:

To achieve this look, order Estate rod, wall mount and all components will be included.

94129061
Zinc



or

1856973
Satin Nickel



or

1856978
Brushed Bronze



or

1857324
Black

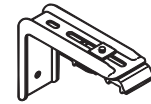

1 3/8" Wall Mount

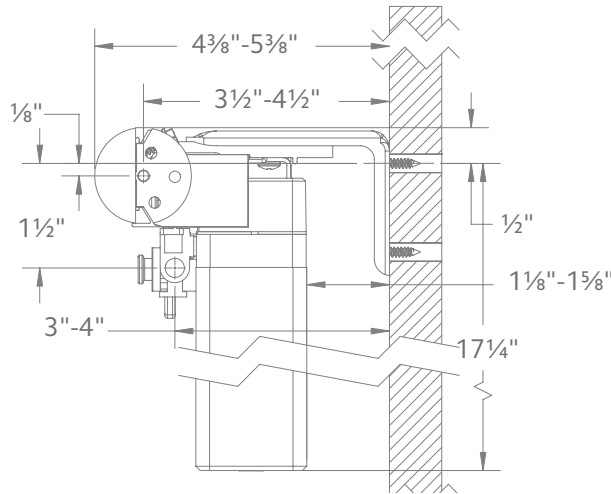

2" Wall Mount

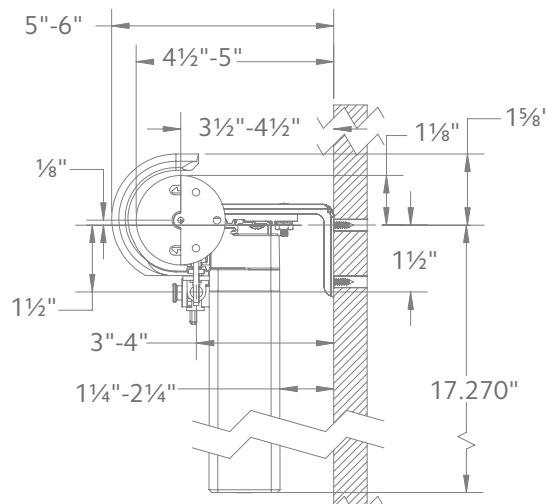

Ceiling Mount using parts:

To achieve this look, order Estate rod, ceiling mounted. 94130xxx brackets are included with the rod. Then order item 1796061 ceiling mount bracket in the quantity needed based on the bracket spacing drawing on page 10.

94130xxx



&

1796061

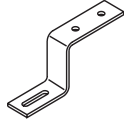

1 3/8" Ceiling Mount

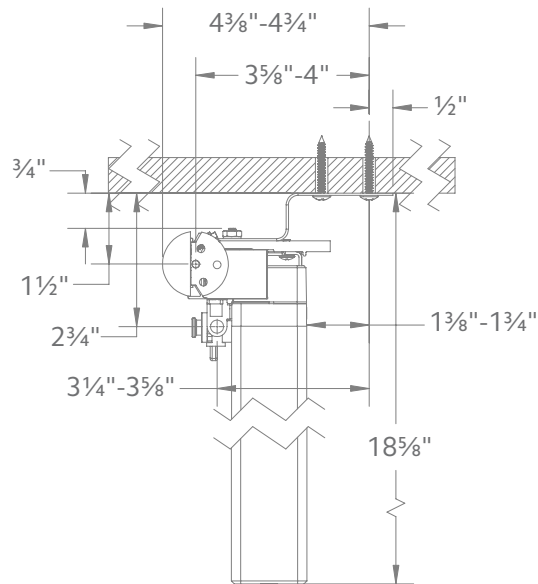

2" Ceiling Mount

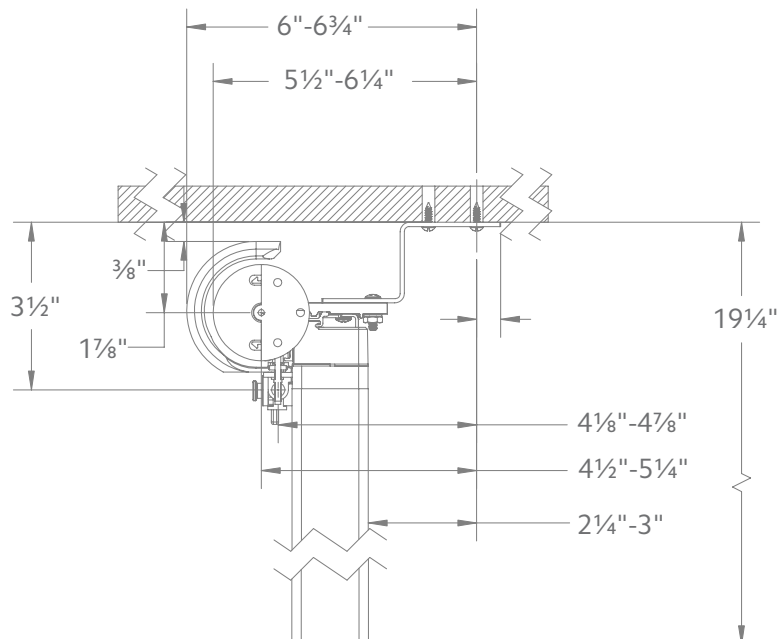

Double Wall Mount using parts:

To achieve this look, order Estate rod, ceiling mounted. 94130xxx brackets are included with the rod. Then order one, item 94125xxx double bracket and two, item 1796061 ceiling mount brackets multiplied by the quantity needed based on the bracket spacing drawing on page 10.

94125xxx



⊗

1796061

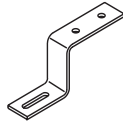

⊗

94130xxx



1 3/8" Double Wall Mount

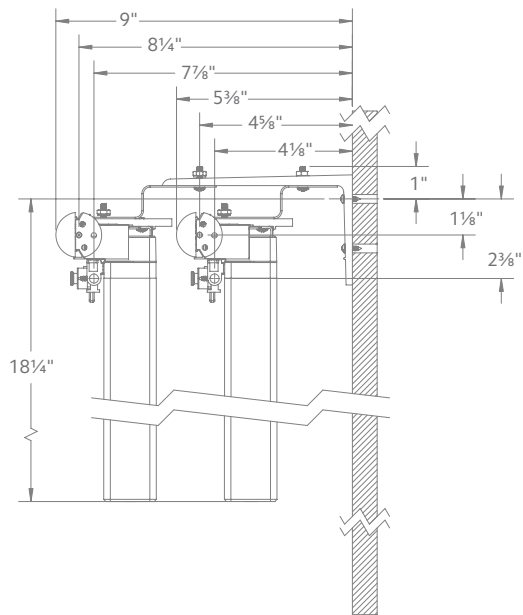



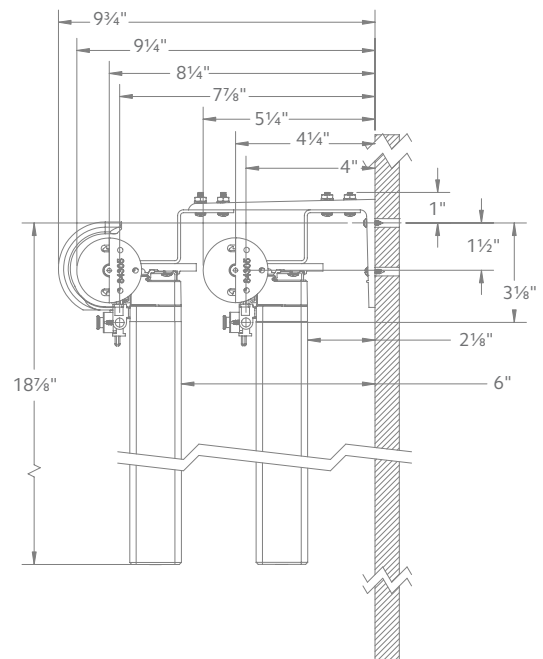



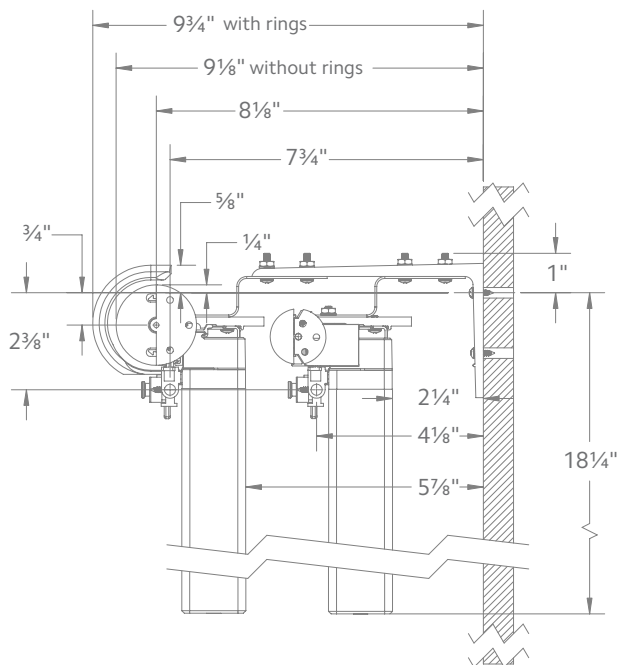





2" Double Wall Mount









2" Front & 1 3/8" Back Double Wall Mount



AMP™ Motorization Components

Item	Product No. & Finish	Description	Unit of Measure
	62001300 White	AMP Motor RF 2W DC Drapery Motor 1.2Nm-20cm 14.8V	1 piece per box
	84531025 White	AMP Drapery Motorhead Adapter Right	10 pieces per box
	84532025 White	AMP Drapery Motor head Adapter Left	10 pieces per box
	84503059 Black 84503025 White	Drapery Motor Master Carrier Adapter	20 pieces per box
	84504025 White	Drapery Motor Front Belt Connector	100 pieces per box
	84505025 White	Drapery Motor Back Belt Connector	100 pieces per box
	84506025 White	Drapery Motor Belt Connector Clip	100 pieces per box
	84510000	Motor Belt	109 yards per box
	62101000 White 62101010 Black	AMP Remote Control RF 2W 15 Channel	1 piece per box
	62201300 White	AMP Battery Charger 16.5V/0.89A	1 piece per box
	62102000 White	AMP Gateway USB Bridge	1 piece per box
	62109000 White	AMP Wall Switch Surface RF 2W 15 Channel	1 piece per box
	62108000	AMP Wall Switch RF 2W 15 Channel	1 piece per box

AMP™ Motorization Components

Item	Product No. & Finish	Description	Unit of Measure
	84509061	Adjustable Pulley Right	1 piece per box
	84508061	Adjustable Pulley Left	1 piece per box
	1026660	15" Cable Assembly	10 pieces per box
	1026661	4' Cable Assembly	10 pieces per box
	1026662	10' Cable Assembly	10 pieces per box
	1026663	20' Cable Assembly	10 pieces per box



Connect your AMP™ motor to the AMP™ USB Bridge for the ultimate control in creating your smart home.

Architrac® Series 94001

Series 94001 Overview

Overview

- AMP™ Motorization available
- Assembled sets includes all necessary components
- Most versatile Architrac® Rod
- Heavy duty, ball bearing pulleys
- Heavy duty, wheeled (Ripplefold™) or ball bearing (pleated) carriers
- Can be curved or bent (not available for motorized tracks)
- Wall or ceiling mount available
- Manual or Motorized Drawn Rods

Available Colors

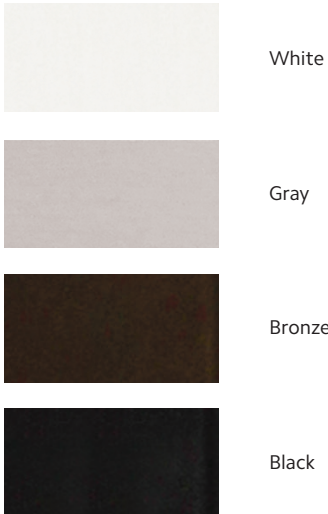

Track Style

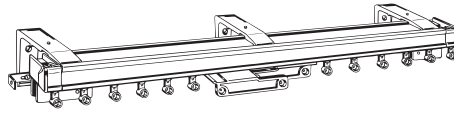

Dimensions

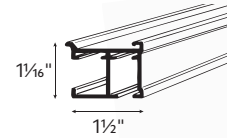

Wall Mount

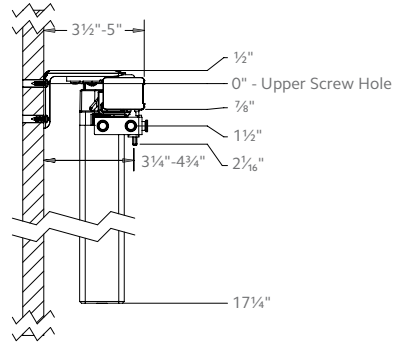

Ceiling Mount

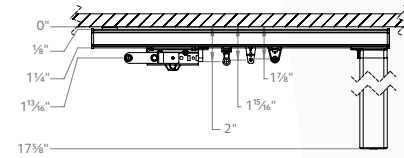

Draw	Mount	Operation	Maximum Track Set	Maximum Fabric Weight	Pounds Per Foot
One-Way	Ceiling	Manual	20'	80 lbs.	4
	Wall	Motorized	16'	64 lbs.	4
Two-Way	Ceiling	Manual	40'	160 lbs.	4
	Wall	Motorized	16'	64 lbs.	4



Series 94001
Shown in white.
Custom sizes only.

1 3/8" Estate™ with AMP™ Motorization

Small but Mighty

The 1 3/8 inch Estate™ rods are our newest decorative traversing drapery rods. Available in our Designer Metals™, Wood Trends™ and Wrought Iron collections, this new smaller size is perfect for smaller spaces while still providing high performing function. The rod may be smaller, but the style is still bold. You can pair any of the 1 3/8 inch finials to complete your design so you never have to sacrifice your brilliant style for performance.

Available Colors

Designer Metals™



Polished Nickel

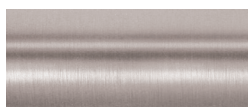

Satin Nickel

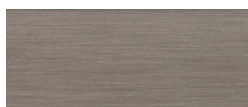

Antique Silver



Black**



Brushed Bronze



Gilded Bronze



Caramel

Wood Trends™



White

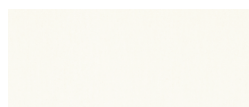

Marble

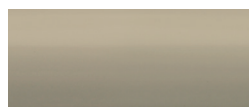

Truffle

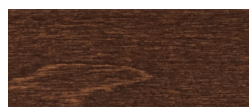

Coffee



Estate Oak



Mahogany



Dark Chocolate



Black



Unfinished

Wrought Iron



Chalk

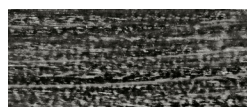

Graphite

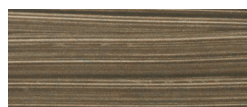

Heirloom Copper

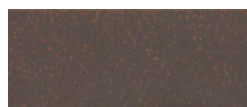

Rust

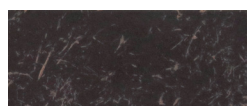

Iron Oxide

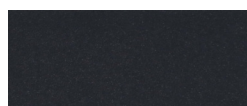

Black

*Select finishes are color coordinated. Refer to price guide for details.



1 3/8" Designer Metals™
Shown in Satin Nickel
Endcap

2" Estate™ with AMP™ Motorization

Evolving the Standard

2 inch Estate™ rods are our standard decorative traversing drapery rods with wheeled carriers that are designed to carry today's heavier draperies. Having set the interior design standard for decades, each of the Estate™ collections are characterized by inspired finials, premium finishes, and precision engineered components. Designer Metals™, Wood Trends™, Varia and Chroma Collections are featured in countless luxury venues and designer homes throughout the world.

Available Colors

Designer Metals™



Polished Nickel

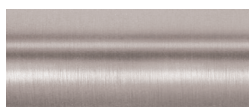

Satin Nickel

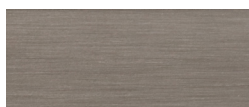

Antique Silver

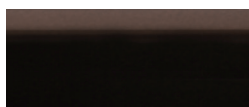

Oil Rubbed Bronze*



Black**



Brushed Bronze



Gilded Bronze

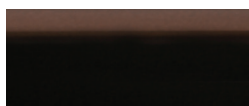

Caramel

Wood Trends™



White

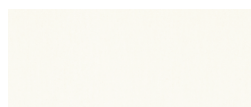

Marble

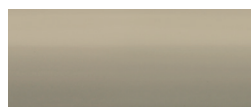

Truffle

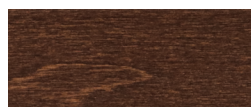

Coffee



Estate Oak



Mahogany



Dark Chocolate



Black



Unfinished

Chroma



Vellum Reflect



Lemon Reflect



Smudge



Rockport

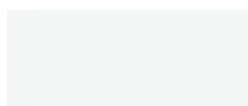

Vellum



Cityscape



Cayman



Mythical



Jello

*Oil Rubbed Bronze with rings uses Black pole with Oil Rubbed Bronze rings.

**Select finishes are color coordinated. Refer to price guide for details.



Varia



Pure Gold

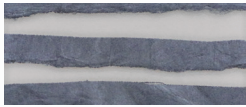

Fray Baltic



Pure Silver

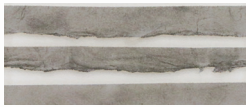

Fray Smoke

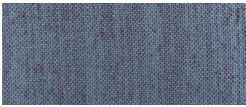

Hem Thames

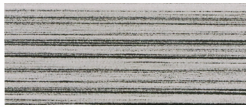

Strand White

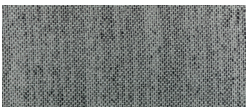

Hem Tetons



Hem Ashland

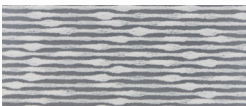

Flock Cotton 2



Connection Mini Pure



Connection Mini Gray

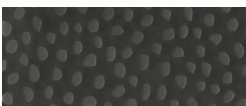

Hint Spotted



2" Varia
Shown in Hem Thames



Kirsch® is proud to extend a 10 year warranty on all Kirsch® Drapery Hardware products manufactured after July 1, 2018 using all Kirsch® components. This is part of our commitment to providing the highest quality products, which has been our continued tradition since 1907.

COVERED

by a 10 year warranty

- Kirsch® Drapery Hardware products are covered for defects in materials, workmanship or failure to operate for 10 years from the date of purchase (unless shorter periods are provided below), provided that the original retail purchaser continues to own the product.
- All internal mechanisms.
- Components, brackets and operational cords.
- Operational cords for a full 7 years from the date of purchase.
- Repairs and/or replacements will be made with like or similar parts or products. Style, color or components may vary depending on original purchase date.
- Kirsch® motorization components are covered for 5 years from the date of purchase.

NOT COVERED

by a 10 year warranty

- Any conditions caused by normal wear and tear.
- Abuse, accidents, misuse or alterations to the product.
- Exposure to the elements (sun damage, wind, water/moisture, salt air) and discoloration or fading over time.
- Normal maintenance associated with motors and related accessories including, but not limited to, recharging and replacement of batteries.
- Failure to follow our instructions with respect to measurement, proper installation, cleaning or maintenance.
- Shipping charges, cost of removal and reinstallation.

Kirsch® (or its licensed fabricators/distributor) will repair or replace the product or components found to be defective.

TO OBTAIN WARRANTY SERVICE

- Contact your original dealer (place of purchase) for warranty assistance.
- Contact Kirsch® at (800) 252-2512 for technical support, certain parts free of charge, for assistance in obtaining warranty service or for further explanation of our warranty.

NOTE: In no event shall Kirsch® or its licensed fabricators/distributor be liable or responsible for incidental or consequential damages or for any other indirect damage, loss, cost or expense. Some states do not allow the exclusion or limitation of incidental or consequential damages, so the above exclusion or limitation may not apply to you. This warranty gives you specific legal rights, and you may also have other rights which vary from state to state.

Different warranty periods and terms apply for commercial products and applications.



Designer Metals™
inspiring brilliance

Wood Trends™
renewing traditions

Wrought Iron
forging artistry

**Custom Rodding
& Basic Hardware**
unique solutions